



SURGICAL INSTRUMENTS

A wonderful serenity has taken possession of my entire soul, like these sweet mornings of spring which I enjoy with my whole heart.



Buck

BS-1-101-18

Percussion Hammer

18.5 cm



Buck

BS-1-102-18

20cm



Dejerine

BS-1-103-20

Percussion Hammer

20cm



Dejerine

BS-1-104-21

Percussion Hammer

21cm



Taylor Mod. USA

BS-1-105-20

Percussion Hammer

20cm



Wartenberg

BS-1-106-19

Pinwheel

18 cm



Pinard

BS-1-107-18

Stethoscope
18 cm



Pinard

BS-1-108-15

Stethoscope
15cm



Magill

BS-2-101-15

Catheter Introducing Forceps
14.5 cm , 20cm, 25 cm



Miller

BS-1-101-18

Laryngoscope Sets



Miller-Baby

BS-2-103-00

Laryngoscope Sets



Miller

BS-2-104-00

Laryngoscope Blade
Fig. 0, Fig. 1, Fig. 2, Fig. 3, Fig. 4



Guedel-Negus

BS-2-105-00

Laryngoscope Sets
Fig. 2, Fig. 3, Fig. 4



Guedel-Negus

BS-2-106-00

Laryngoscope Sets
Fig. 1, Fig. 2, Fig. 3, Fig. 4



Guedel-Negus

BS-2-107-01

Laryngoscope Blades
Fig. 1, Fig. 2, Fig. 3, Fig. 4



McIntosh

BS-2-108-00

McIntosh



McIntosh

BS-2-109-0

Laryngoscope Blades
Fig. 0, Fig. 1, Fig. 2, Fig. 3, Fig. 4



McIntosh

BS-2-110-00

Laryngoscope Sets
Fig. 1, Fig. 2, Fig. 3, Fig. 4



Foregger

BS-2-111-01

Laryngoscope Blades
Fig. 1, Fig. 2, Fig. 3, Fig. 4



Battery Handle

BS-2-112-00

Battery Handle



McIntosh

BS-2-114-00

Laryngoscope Sets fiber optic
Fig. 1, Fig. 2, Fig. 3



McIntosh

BS-2-115-00

Laryngoscope Sets fiber optic
Fig. 1, Fig. 2, Fig. 3



McIntosh

BS-2-116-00

Laryngoscope Sets fiber optic
Fig. 1, Fig. 2, Fig. 3



McIntosh

BS-2-113-00

Laryngoscope Sets
Fig. 1, Fig. 2, Fig. 3, Fig. 4



Universal

BS-3-101-04

Trocar
14 cm



Nelson

BS-3-102-07

Trocar
20cm



Lichtwitz

BS-3-103-19

Antrum Trocar
18.5 cm



Adson

BS-3-104-21

Suction Cannula
20cm



Frazier

BS-3-105-10

Suction Cannula
24 cm



Frazier

BS-3-106-06

Suction Cannula
19.5 cm



Poppen
BS-3-107-06
 Suction Cannula
 18 cm



Luer
BS-3-108-30
 Suction Tube working length 110 mm



Yasargil
BS-3-109-15
 Suction Tube working length 150 mm with Luer
 hub



Yankauer
BS-3-110-27
 Suction Tube complete with suction tip and
 connector
 31 cm



Yankauer
BS-3-111-00
 Suction Tube
 31 cm , 15 cm, 2.5 cm, 10 cm



Poole
BS-3-112-22
 Suction Tube
 22cm



Poole

BS-3-113-22

Suction Tube
22.5 cm



Nuboer

BS-3-114-21

Suction Tube
21cm



Nuboer

BS-3-115-21

Suction Tube
21cm



Quinke

BS-3-116-10

Lumbar Puncture Needle



Tuohy

BS-3-117-12

Lumbar Puncture Needle Luer Lock connection
with special tip



Verres

BS-3-118-20

Insufflation Cannula Luer Lock connection
15 cm



Verres

BS-3-119-20

Insufflation Cannula Luer Lock connection
17 cm



Kalt
BS-4-105-14
 Needle Holder
 13.5 cm



Barraquer-Troutman
BS-4-106-10
 Micro Needle Holder
 10 cm , 10.5 cm



Arruga
BS-4-107-14
 Micro Needle Holder
 13.5 cm



Barraquer-Troutman
BS-4-108-10
 Micro Needle Holder
 10.5 cm , 11.5cm



Barraquer
BS-4-109-11
 Micro Needle Holder
 11.5cm, 13.5 cm , 14 cm



Barraquer
BS-4-110-13
 Micro Needle Holder
 13.5 cm



Castroviejo-Fino

BS-4-111-01

Micro Needle Holder
13cm



Castroviejo-Fino

BS-4-112-01

Micro Needle Holder
13cm



Castroviejo-Fino

BS-4-113-01

very delicate jaw with lock
13cm



Castroviejo

BS-4-114-14

Micro Needle Holder with lock
Fig.65, Fig.69, Fig.88 L, 14 cm



Castroviejo

BS-4-115-14

Micro Needle Holder
14 cm



Castroviejo

BS-4-121-14

Micro Needle Holder with lock
14 cm



Castroviejo

BS-4-122-14

Micro Needle Holder
14 cm



Castroviejo

BS-4-124-13

Micro Needle Holder with lock



Arruga

BS-4-123-16

Needle Holder delicate
16 cm



Castroviejo

BS-4-125-12

Micro Needle Holder with lock
12 cm



Derf

BS-4-126-12

Needle Holder
12 cm, 13cm

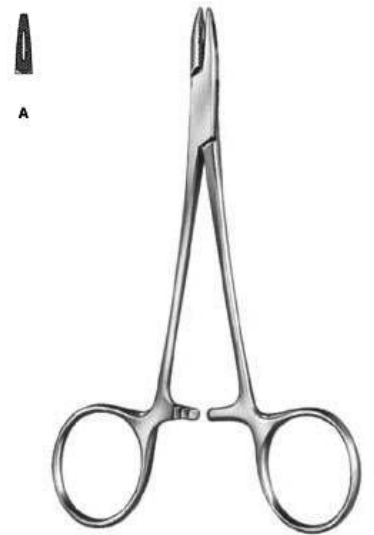

Collier

BS-4-127-12

Needle Holder
12.5 cm



Webster

BS-4-128-13

Needle Holder
13cm



Halsey

BS-4-129-13

Needle Holder
13.5 cm

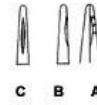

Neivert

BS-4-130-13

Neivert
12.5 cm



Metzenbaum

BS-4-141-18

Needle Holder one grooved and fenestrated jaw
18.5 cm



M. G. Hospital

BS-4-142-17

Needle Holder
17.5 cm



Mayo-Hegar

BS-4-143-14

Needle Holder
14.5 cm , 16 cm , 18.5 cm , 24 cm



Adson

BS-4-140-18

Needle Holder one fenestrated jaw
18 cm



Metzenbaum

BS-4-141-18

Needle Holder one grooved and fenestrated jaw
18.5 cm



M. G. Hospital

BS-4-142-17

Needle Holder
17.5 cm

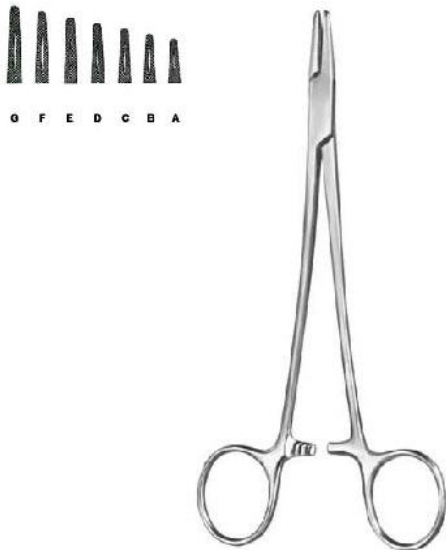

Mayo-Hegar

BS-4-143-14

Needle Holder

14.5 cm , 16 cm , 18.5 cm , 20.5 cm , 24 cm , 26.5 cm

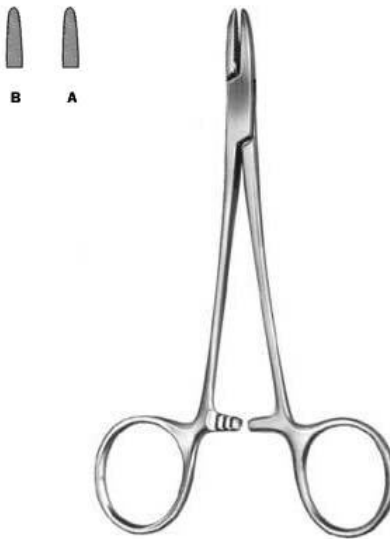

Brown

BS-4-145-13

Needle Holder

13cm, 18 cm



Mayo Hegar

BS-4-144-16

Needle Holder

16 cm , 18.5 cm , 20.5 cm

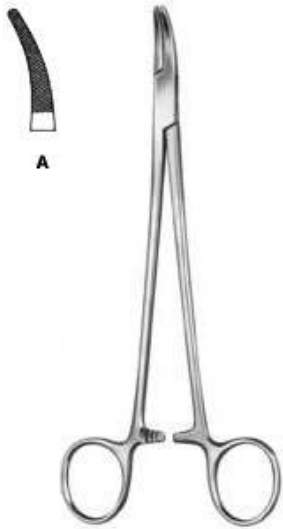

Heaney

BS-4-146-21

Needle Holder
20.5 cm

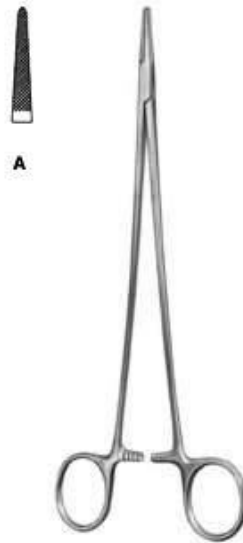

Jamison

BS-4-147-23

Needle Holder
23.5 cm



Masson

BS-4-148-27

Needle Holder
26.5 cm

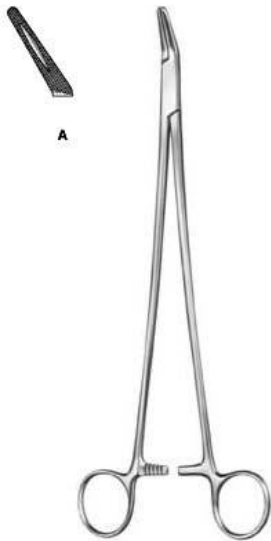

Finochietto

BS-4-149-27

Needle Holder
26.5 cm



Wangensteen

BS-4-150-27

Needle Holder
26.5 cm

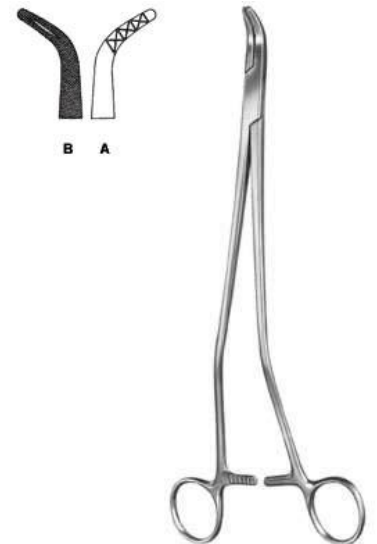

Johnson

BS-4-151-27

Needle Holder
27 cm

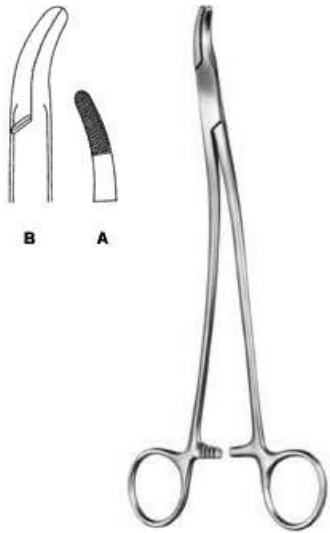

Stratte

BS-4-152-23

Needle Holder
23 cm

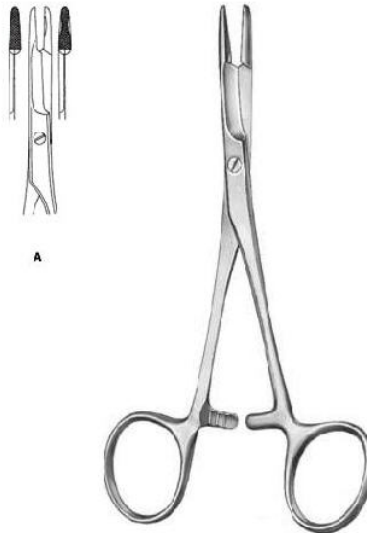

Olsen-Hegar

BS-4-153-14

Needle Holder
14 cm

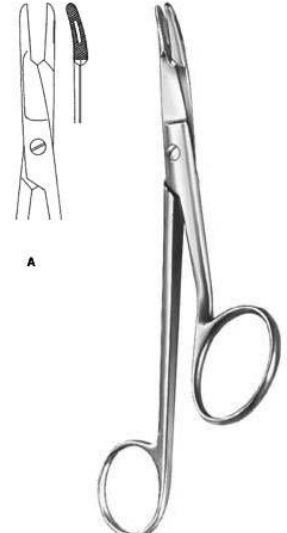

Gillies

BS-4-154-16

Needle Holder
16 cm



Crile

BS--155-15

Needle Holder
15 cm



Mathieu

BS-4-156-14

Needle Holder
14 cm, 17 cm, 20 cm



Mathieu

BS-4-157-14

Needle Holder
16.5 cm



Toennis

BS-4-158-18

Needle Holder
18.5 cm



Lichtenberg

BS-4-159-20

Needle Holder
20cm



Micro Needle Holder

BS-4-160-16

Micro Needle Holder
16 cm

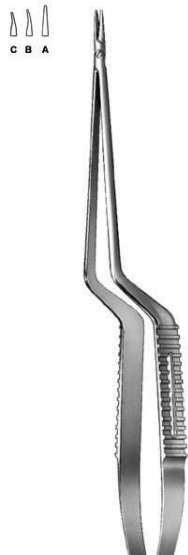

Micro Needle Holder

BS-4-161

Micro Needle Holder
19 cm



Hepp-Scheidel

BS-4-162-18

Micro Needle Holder smooth jaw
18 cm

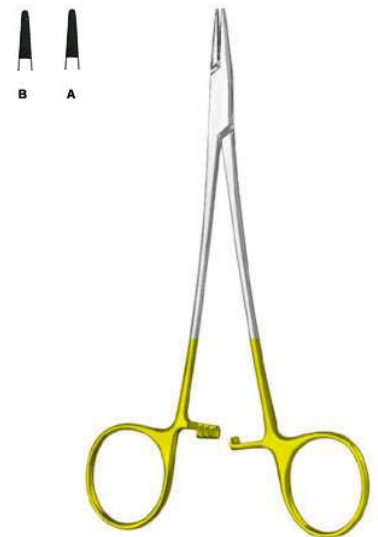

Webster

BS-4-163-13

Needle Holder with automatic release ratchet
also for lefthanders
Fig.233, 16 cm , 12 cm, 13cm, 15 cm



Micro Needle Holder

BS-4-164-15

Micro Needle Holder
15 cm, 18 cm, 21cm, 23 cm



JABOMA

BS-4-165-18

Micro Needle Holder
18 cm



Castroviejo

BS-4-166

Micro Needle Holder
Fig.233, 16 cm , 12 cm , Fig.18 L, 14.5 cm , 18 cm,
21cm



Arruga

BS-4-167

Needle Holder
Fig.233, 16 cm , 12 cm, Fig.18 L, 16 cm



Castroviejo

BS-4-168-13

Micro Needle Holder
12.5 cm



Barraquer

BS-4-169-13

13 cm



Barraquer

BS-4-170-13

Micro Needle Holder

13 cm



Webster

BS-4-171-13

Needle Holder

13 cm



Derf

BS-4-173-12

Needle Holder

12 cm

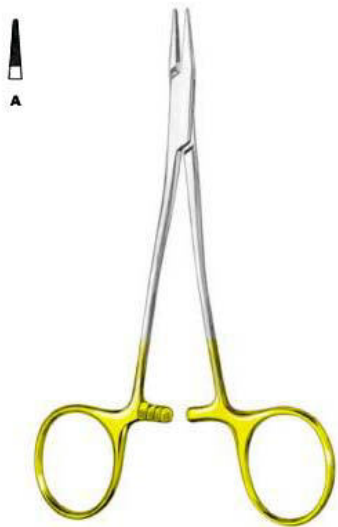

Kilner

BS-4-172-13

13 cm



Hegar-Baumgartner

BS-4-174-13

Needle Holder

13 cm , 14.5 cm



Halsey

BS-4-175-12

Needle Holder

13 cm , 12 cm



Crile-Wood

BS-4-176-15

Needle Holder
15 cm



Sarot

BS-4-177-18

Needle Holder
18 cm, 20 cm, 26 cm

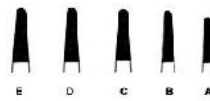

Mayo-Hegar

BS-4-178-16

Needle Holder standard profile
16 cm, 18 cm, 20 cm, 24 cm, 26 cm, 30 cm



Heaney

BS-4-179-20

Needle Holder
20 cm, 24 cm, 26 cm

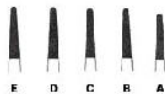

DeBakey

BS-4-180-18

Needle Holder delicate pattern mini profile
18 cm, 20 cm, 23 cm, 26 cm, 31 cm



Masson

BS-4-181-27

Needle Holder
26.5 cm



Ryder (Martin)

BS-4-182-13

Needle Holder

12.5 cm, 15 cm, 18 cm, 20 cm, 23 cm, 26 cm

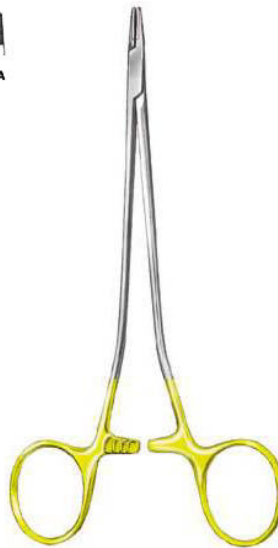

Martin

BS-4-183-15

Needle Holder mini profile elastic type

15 cm, 17 cm, 20 cm



Wangensteen

BS-4-184-27

Needle Holder standard profile

27 cm



Hegar-Vascular

BS-4-185-14

Needle Holder micro profile

14 cm, 18.5 cm, 20.5 cm, 23 cm

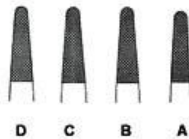

Bozemann

BS-4-186-20

Needle Holder standard profile

20.5 cm, 24 cm, 26.5 cm, 29 cm



Hegar

BS-4-187-20

Needle Holder standard profile

20 cm, 23.5 cm

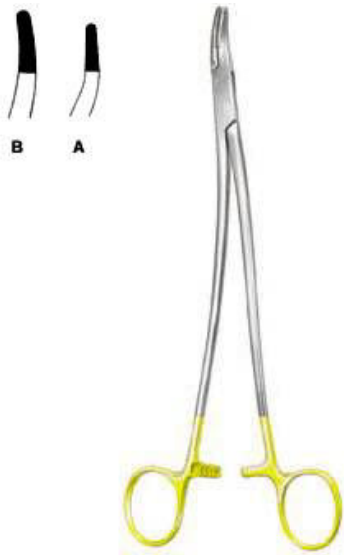

Stratte

BS-4-188-22

Needle Holder standard profile
23 cm



Microvascular

BS-4-189-00

Needle Holder slender pattern micro profile
14 cm, 17.5 cm, 20 cm, 23 cm



Mathieu

BS-4-190-14

Needle Holder
14 cm, 17 cm, 20 cm



Mathieu

BS-4-191-14

Needle Holder
14 cm, 17 cm, 20 cm



Mathieu

BS-4-192-17

Needle Holder standard profile with interior
ratchet
17 cm, 20 cm, 23 cm



Toennis

BS-4-193-18

Needle Holder
18.5 cm



Lichtenberg

BS-4-194-20

Needle Holder lightweight model standard profile
20 cm



Langenbeck

BS-4-195-18

Needle Holder
18 cm, 20.5 cm, 23 cm



Zweifel

BS-4-196-20

Needle Holder with hinged ratchet standard
profile
20.5 cm, 23 cm

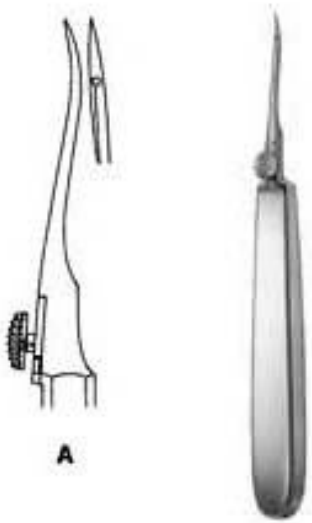

Reverdin

BS-4-197-15

Reverdin Needle short
14 cm Fig. 1, 14 cm Fig. 2, 14 cm Fig. 3, 14 cm
Fig. 4

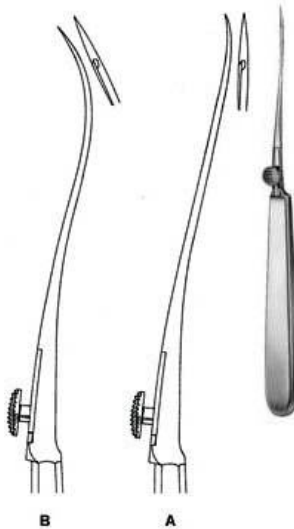

Reverdin

BS-4-198-19

Reverdin Needle medium
19.5 cm Fig. 1, 19.5 cm Fig. 2, 19.5 cm Fig. 3, 19.5
cm Fig. 4

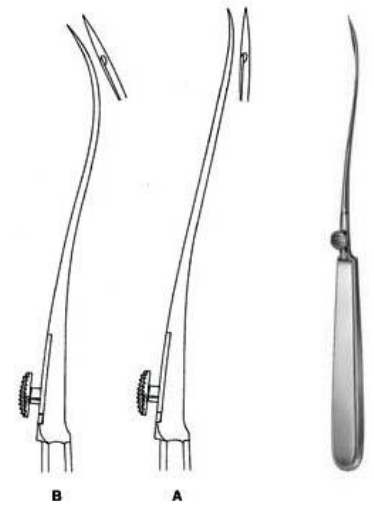

Reverdin

BS-4-199-23

Reverdin Needle long
23 cm Fig. 1, 23 cm Fig. 2, 23 cm Fig. 3, 23 cm Fig.
4

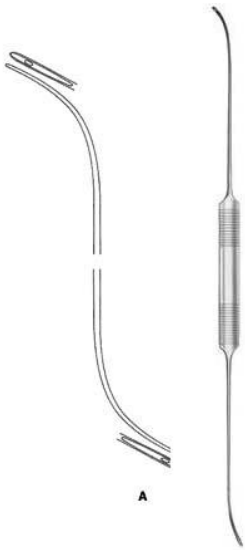

Schmieden-Dick

BS-4-201-01

Ligature Needle malleable
29 cm

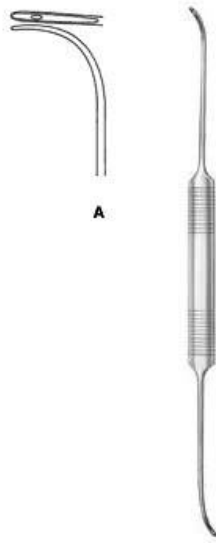

Schmieden

BS-4-202-21

Ligature Needle
24 cm



Ligature Needle Malleable

BS-4-203-20

Ligature Needle malleable
20.5 cm

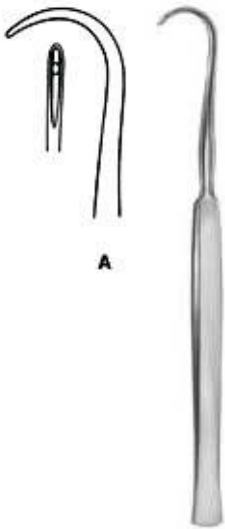

Cooper

BS-4-204-19

Ligature Needle
18.5 cm



Kronecker

BS-4-205-13

Ligature Needle delicate for right hand
12.5 cm

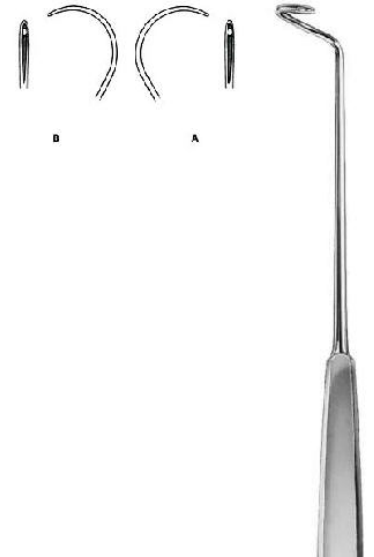

Deschamps

BS-4-206-24

24 cm



Deschamps

BS-4-207-20

Ligature Needle blunt for right hand
20 cm

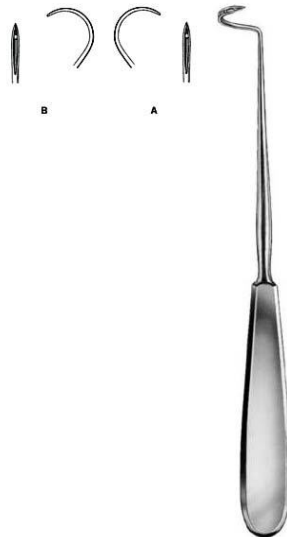

Deschamps

BS-4-208-20

Ligature Needle sharp for right hand
20 cm

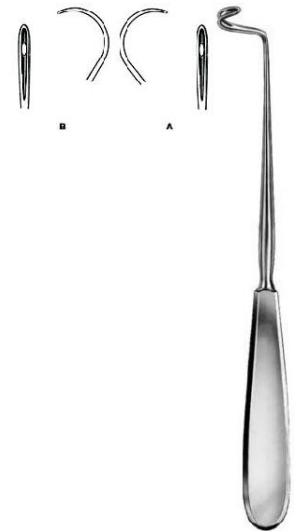

Deschamps

BS-4-209-21

Ligature Needle blunt for right hand
20 cm

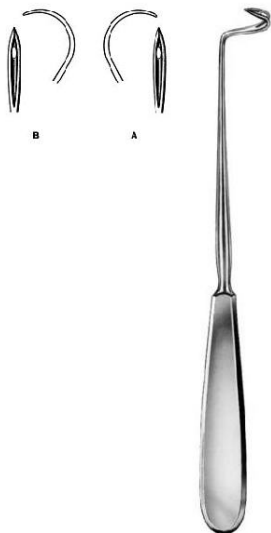

Deschamps

BS-4-210-21

Ligature Needle sharp for right hand
20 cm

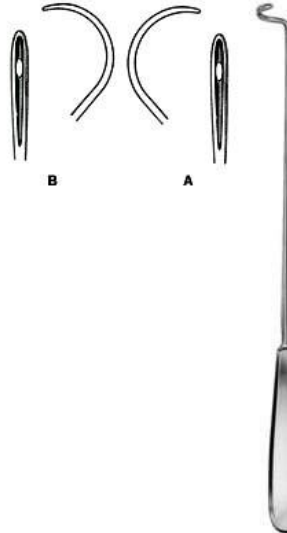

Deschamps

BS-4-211-27

Ligature Needle blunt for right hand
27 cm

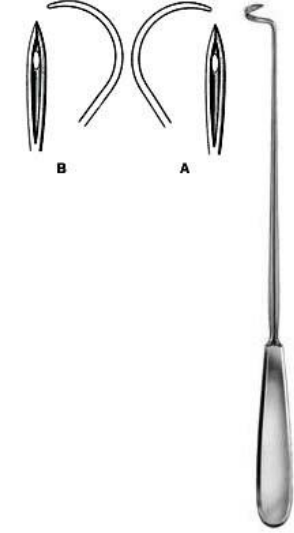

Deschamps

BS-4-212-27

Ligature Needle sharp for right hand
27 cm

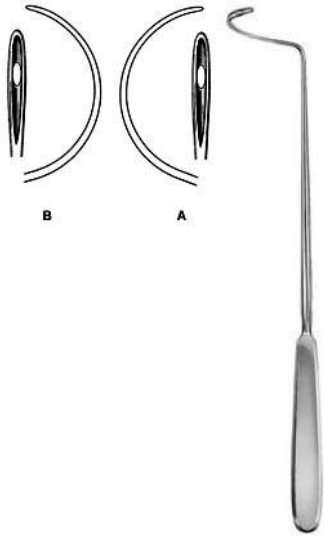

Deschamps

BS-4-213-28

28 cm

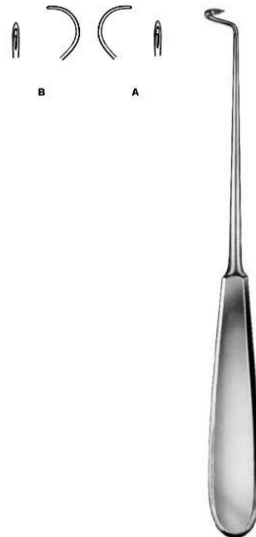

Deschamps

BS-4-214-20

Ligature Needle sharp for right hand

20 cm



Deschamps

BS-4-215-20

Ligature Needle blunt for right hand

20 cm



Deschamps

BS-4-216-20

Ligature Needle blunt for right hand

21 cm

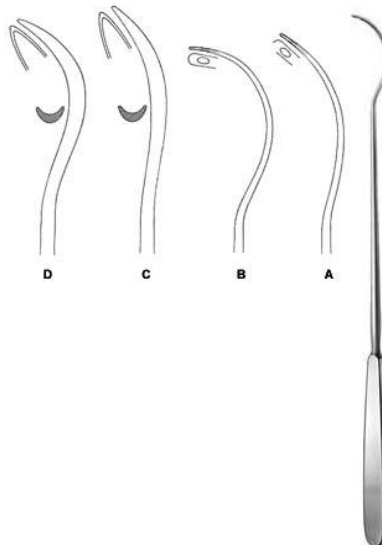

Brunner

BS-4-217-30

Ligature Needle

21 cm



Kirschner

BS-4-218-25

Ligature Conductor

25.5 cm

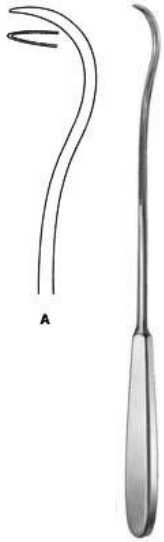

Ligature Conductor

BS-4-219-28

Ligature Conductor
28 cm



Modell Wien

BS-4-220-23

Ligature Catcher
23.5 cm



Michel

BS-4-221-12

Clip Applying Forceps
12 cm



Hegenbarth

BS-4-222-12

Clip Applying Forceps
12 cm

Scalpels



Dissecting Knife

BS-5-101-01

Dissecting Knife with metal handle
15 cm, 15.5 cm, 16 cm , 17 cm



Autopsy Knife

BS-5-102-10

Autopsy Knife
25.5 cm

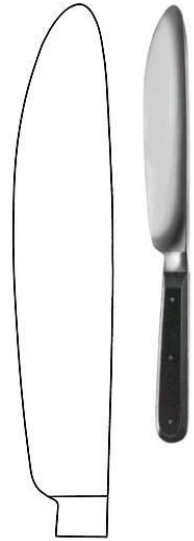

Walb

BS-5-104-17

Post Mortem Knife

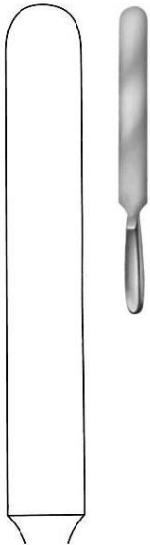

Virchow

BS-5-105-20

Virchow
28.5 cm, 33.5 cm, 38 cm



Scalpel Handle

BS-5-108-04

Scalpel Handle
13.5 cm



Scalpel Handle

BS-5-109-34

Scalpel Handle
16 cm



Scalpel Handle

BS-5-110-41

Scalpel Handle

21cm



Scalpel Handle

BS-5-111-45

Scalpel Handle

21cm



Collin

BS-5-112-08

Scalpel Handle with hollow handle

13.5 cm



Collin

BS-5-113-09

Scalpel Handle with hollow handle

14.5 cm



Scalpel Handle

BS-5-114-03

Scalpel Handle

12 cm



Scalpel Handle

BS-5-115-04

Scalpel Handle

12 cm

Scalpels



Scalpel Handle

BS-5-116-05

Scalpel Handle

12 cm



Scalpel Handle

BS-5-117-31

Scalpel Handle

21.5 cm



Scalpel Handle

BS-5-118-35

Scalpel Handle

21cm



Scalpel Handle

BS-5-119-07

Scalpel Handle

16 cm



Scalpel Handle

BS-5-120-71

Scalpel Handle

12.5 cm



Scalpel Handle

BS-5-121-03

Scalpel Handle

15.5 cm



Amputation Knife

BS-5-127-16

Amputation Knife
29 cm



Amputation Knife

BS-5-128-19

Amputation Knife
32.5 cm



Catlin

BS-5-129-16

Interosseous Knife with hollow handle
29 cm



Resection Knife

BS-5-130-06

Resection Knife
18 cm



Langenbeck

BS-5-131-05

Resection Knife
18 cm



Langenbeck

BS-5-132-05

Langenbeck
18 cm



Razor Knife

BS-5-133-00

Razor Knife hollow blades on both sides cutting length 75mm



Schink

BS-5-134-00

Dermatome complete with 2 skin fixing plates and one blade 31 cm



Schink

BS-5-135-01

Spare Blade spare blade for KE-05-134-00



Schink

BS-5-136-02

Skin Fixing Plate for KE-05-134-00



Standard BL / BL Straight

BS-5-201-13

Operating Scissor Special Price: \$1.25
12 cm, 13cm, 14.5 cm , 16.5 cm , 18.5 cm , 20.5 cm



Standard SH / BL STR

BS-5-202-13

Operating Scissors
12 cm, 13cm, 14.5 cm , 16.5 cm , 18.5 cm , 20.5 cm



Standard SH / SH STR

BS-5-204-13

Operating Scissors
12 cm, 13cm, 14.5 cm , 16.5 cm



Standard BL / BL Curved

BS-5-205-13

Operating Scissors
12 cm, 13cm, 14.5 cm , 16.5 cm , 18.5 cm , 20.5 cm



Standard SH / BL Curved

BS-5-206-13

Operating Scissors
12 cm, 13cm, 14.5 cm , 16.5 cm , 18.5 cm , 20.5 cm



Standard SH / SH Curved

BS-5-207-13

Operating Scissors
12 cm, 13cm, 14.5 cm , 16.5 cm



Standard BL / BL Curved

BS-5-208-14

Operating Scissors delicate
14.5 cm



Incision Scissor

BS-5-209-14

Operating Scissor
14.5 cm



Deaver

BS-5-210-14

Operating Scissor



Mayo

BS-5-211-15

Dissecting Scissors
14.5 cm , 15 cm , 17 cm , 23.5 cm

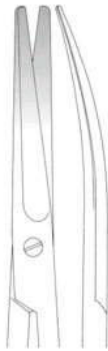

Mayo

BS-5-212-23

Dissecting Scissors
23 cm , 22.5 cm , 28 cm



Mayo-Harrington

BS-5-213-22

Dissecting Scissors
23 cm , 22.5 cm , 28 cm

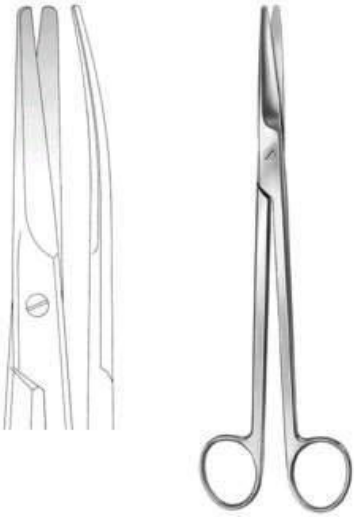

Mayo-Harrington

BS-5-214-22

Dissecting Scissors cur
22.5 cm, 23 cm , 28 cm

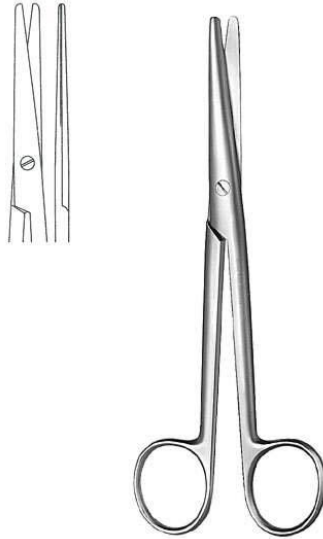

Mayo-Stille

BS-5-215-17

Dissecting Scissors str
15 cm, 17 cm

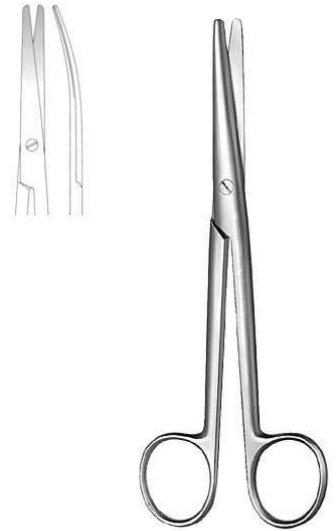

Mayo-Stille

BS-5-216-15

Dissecting Scissors cur
15 cm, 17 cm

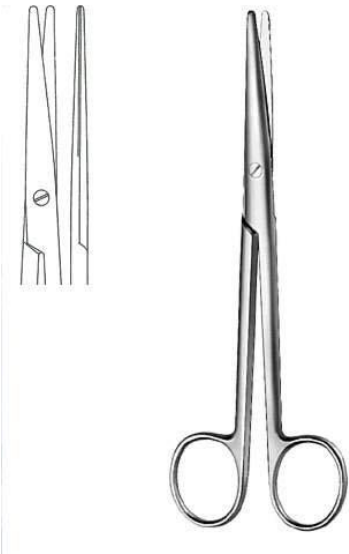

Mayo-Stille

BS-5-217-19

Dissecting Scissors cur
16 cm, 19.5 cm , 21.5 cm

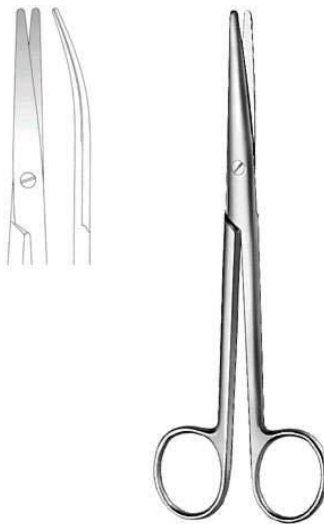

Mayo-Stille

BS-5-218-16

Dissecting Scissors cur
16 cm, 19.5 cm , 21.5 cm



Mayo-Noble

BS-5-219-17

Gynecological Scissors
16.5 cm



Sims

BS-5-220-23

Gynecological Scissors str
20cm, 23 cm



Sims

BS-5-221-20

Gynecological Scissors cur
20cm, 23 cm



Kelly

BS-5-222-16

Operating Scissors
16 cm



Doyen

BS-5-223-17

Gynecological Scissors
18.5 cm



Sims-Siebold

BS-5-224-24

Gynecological Scissors
24.5 cm



Sims-Siebold

BS-5-225-24

Gynecological Scissors
24.5 cm



Wertheim

BS-5-226-23

Gynecological Scissors
20cm, 23 cm



Metzenbaum

BS-5-227-11

Dissecting Scissors
11



Metzenbaum

BS-5-228-14

Dissecting Scissors
14.5 cm



Metzenbaum

BS-5-229-15

Dissecting Scissors
15.5 cm



Metzenbaum-Nelson

BS-5-230-20

Dissecting Scissors
18 cm, 20.5 cm, 23 cm , 26 cm, 28.5 cm, 31 cm



Metzenbaum-Nelson

BS-5-231-20

Dissecting Scissors
18 cm, 20.5 cm



Metzenbaum-Nelson

BS-5-232-20

Dissecting Scissors

18 cm, 20.5 cm, 23 cm , 26 cm, 28.5 cm, 31 cm



Metzenbaum

BS-5-233-14

Dissecting Scissors toothed

14.5 cm



Nerve Operating Scissor

BS-5-234-15

Dissecting Scissors

15.5 cm

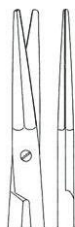

Gorney

BS-5-235-19

Face-lift Scissors str

12.5 cm, 19.5 cm



Gorney

BS-5-236-19

Face-lift Scissors cur

19.5 cm



Aston

BS-5-237-17

Face-lift Scissors

17 cm



Lexer

BS-5-238-16

Dissecting Scissors
16 cm



Cinelli

BS-5-239-14

Nasal Scissors
11.5cm, 14 cm



Thorek

BS-5-240-19

Dissecting Scissors
18.5 cm



Lexer-Baby

BS-5-241-10

Dissecting Scissors
10 cm



Lexer-Fino

BS-5-242-16

Delicate Dissecting Scissors slender pattern
16.5 cm



Metzenbaum-Fino

BS-5-243-14

Delicate Dissecting Scissors slender pattern
14.5 cm



Metzenbaum-Fino

BS-5-244-14

Delicate Dissecting Scissors
14.5 cm



Metzenbaum-Fino

BS-5-245-14

Delicate Dissecting Scissors
14.5 cm



Metzenbaum-Fino

BS-5-246-14

Delicate Dissecting Scissors
14.5 cm

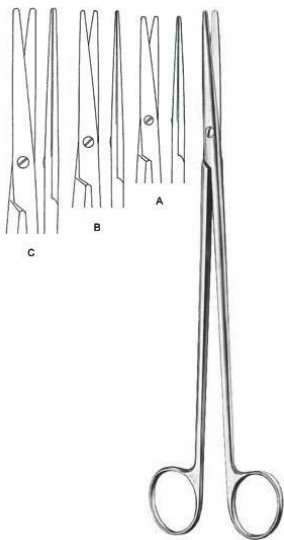

Metzenbaum-Fino

BS-5-247-18

Delicate Dissecting Scissors slender pattern
18 cm, 20cm, 23 cm

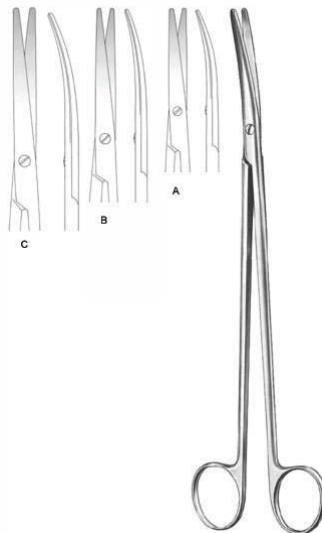

Metzenbaum-Fino

BS-5-248-18

Delicate Dissecting Scissors slender pattern
18 cm, 20cm, 23 cm

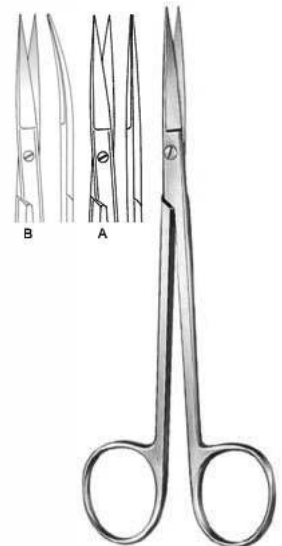

Sanvenero

BS-5-250-14

Operating Scissors
14 cm

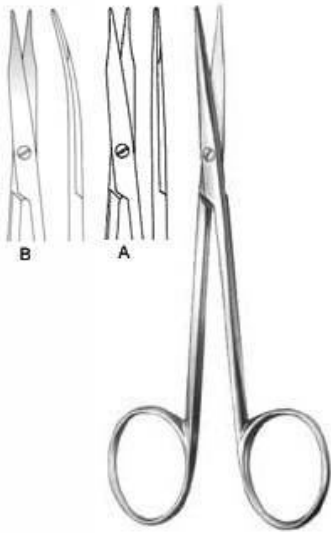

Fine Operating Scissors

BS-5-251-11

Fine Operating Scissors
11.5cm

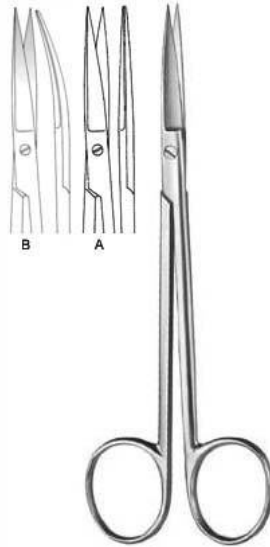

Joseph

BS-5-252-14

Operating Scissors
14.5 cm

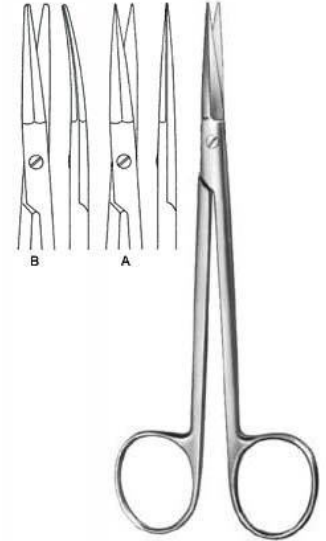

Peck-Joseph

BS-5-253-14

Face-lift Scissors
14.5 cm

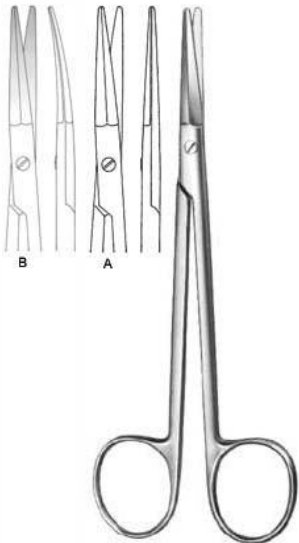

Peck-Joseph

BS-5-254-14

Face-lift Scissors
14.5 cm



Shea Vein Graft

BS-5-255-12

Dissecting Scissors
12 cm

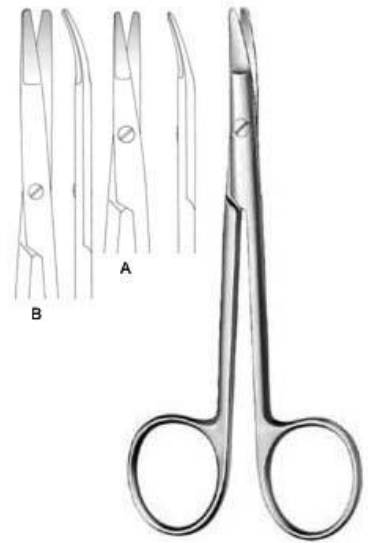

Kilner

BS-5-256-12

Dissecting Scissors
12 cm, 15 cm

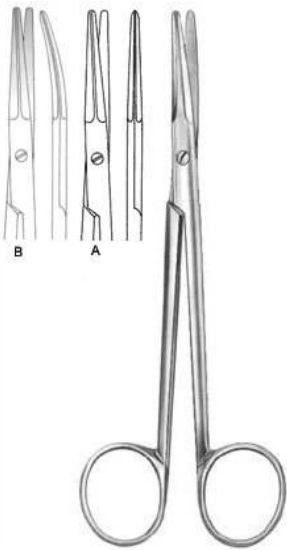

Dissecting Scissors

BS-5-257-14

Dissecting Scissors
14.5 cm

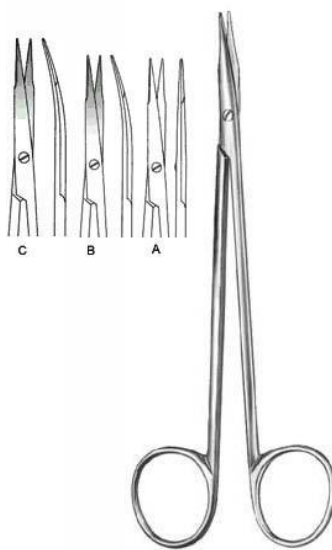

Reynolds

BS-5-258-15

Dissecting Scissors
15.5 cm, 18 cm



Jameson

BS-5-259-14

Dissecting Scissors
15.5 cm



Jameson

BS-5-260-14

Dissecting Scissors
15.5 cm



Vascular Scissors

BS-5-261-19

Vascular Scissors
19 cm

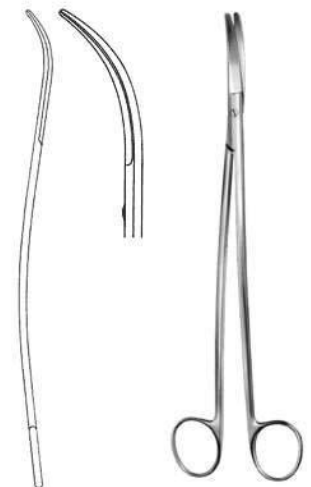

Vascular Scissors

BS-5-262-24

Vascular Scissors
19 cm, 25.5 cm

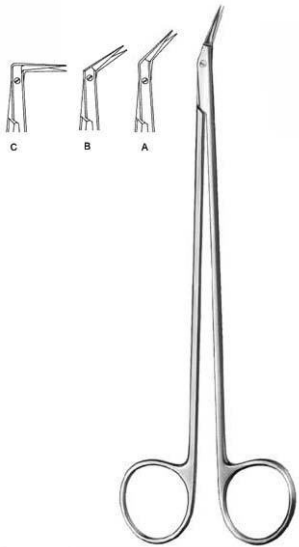

Diethrich

BS-5-263-25

ascular Scissors
17.5 cm, 18.5 cm , 19 cm

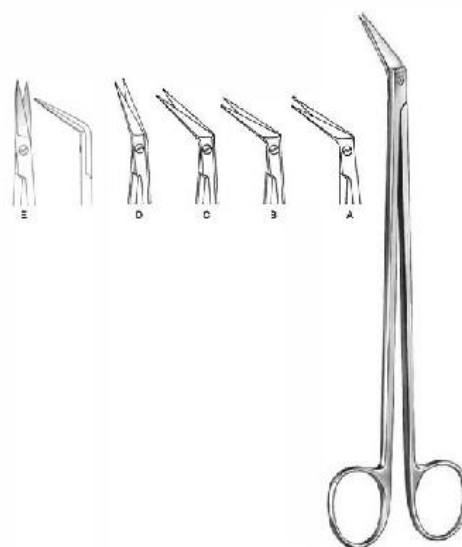

DeBakey

BS-5-264-45

ascular Scissors
16 cm, 16.5 cm

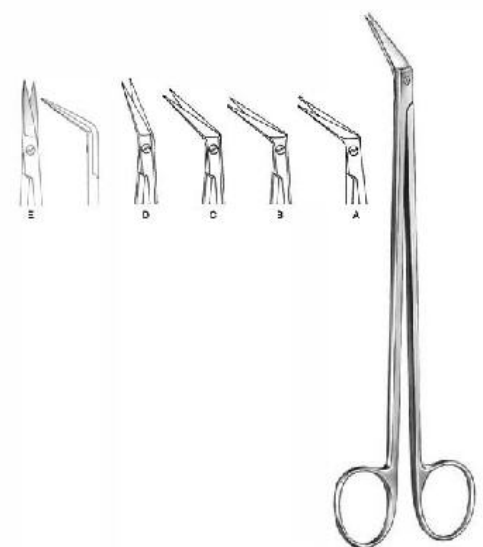

Potts-Smith

BS-5-265-19

Vascular Scissors
18 cm, 18.5 cm , 19 cm



Coronary Scissors

BS-5-267-45

Cardiovascular Surgery Scissors
18 cm



Coronary Scissors

BS-5-267-45

Cardiovascular Surgery Scissors
18 cm



Coronary Scissors

BS-5-268-60

Cardiovascular Surgery Scissor
18 cm



Coronary Scissors

BS-5-269-90

Cardiovascular Surgery Scissor
18 cm



Coronary Scissors

BS-5-270-00

Cardiovascular Surgery Scissor
18 cm



Coronary Scissors

BS-5-271-00

Cardiovascular Surgery Scissor
18 cm



Coronary Scissors

BS-5-272-25

Cardiovascular Surgery Scissor
18 cm



Coronary Scissors

BS-5-273-45

Cardiovascular Surgery Scissor
18 cm



Coronary Scissors

BS-5-274-90

Cardiovascular Surgery Scissor
18 cm



Schmieden-Taylor

BS-5-275-17

Dura Scissors
15 cm



Strully

BS-5-276-22

Neurosurgical Scissors
22.5 cm



Toennis-Adson

BS-5-277-17

Dissecting Scissors
17.5 cm



Good

BS-5-279-19

Tonsil Scissors
19.5 cm



Fomon

BS-5-282-15

Nasal Scissors
15 cm



Cottle

BS-5-283-16

Nasal Scissors
16 cm



Heymann

BS-5-284-18

Nasal Scissors
18.5 cm



Heymann

BS-5-285-18

Nasal Scissors
18.5 cm



Converse

BS-5-286-11

Nasal Scissors blunt & sharp
10.5 cm



Waldmann

BS-5-287-18

Episiotomy Scissors
18 cm



Braun-Stadler

BS-5-268-60

Episiotomy Scissors
14.5 cm



Braun-Stadler

BS-5-289-22

Episiotomy Scissors
22cm



Modell USA

BS-5-290-10

Umbilical Scissors
10.5 cm



Busch

BS-5-292-16

Umbilical Scissors
16 cm



Goldmann-Fox

BS-5-293-13

Gum Scissors
13cm



Wagner

BS-5-294-12

Operating Scissors
12 cm

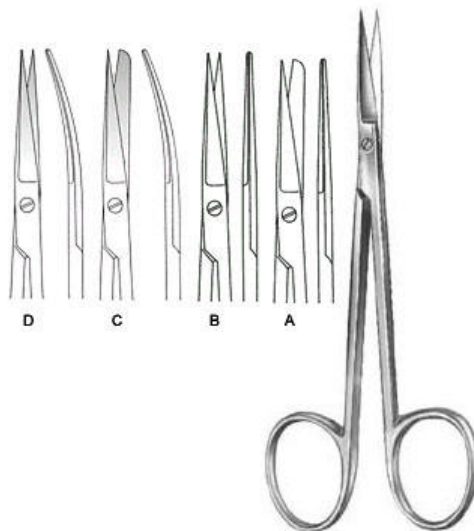

Operating Scissors

BS-5-295-12

Operating Scissors small model
12 cm



La Grange

BS-5-296-11

Gum Scissors S-shaped
11.5cm



Dissecting Scissors

BS-5-297-11

Dissecting Scissors 11.5cm
11.5cm



Locklin

BS-5-298-16

Gum Scissors 16cm
16 cm



Locklin

BS-5-299-16

Gum Scissors
16 cm



Operating Scissors

BS-5-300-08

Operating Scissors
9

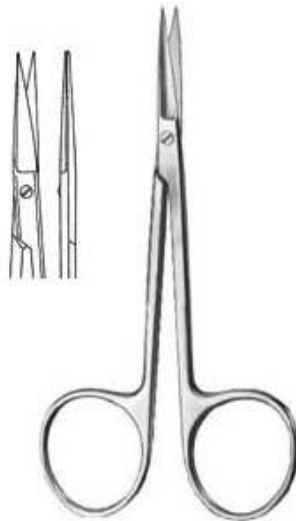

Iris Scissors

BS-5-301-10

Iris Scissors
9 cm, 10 cm

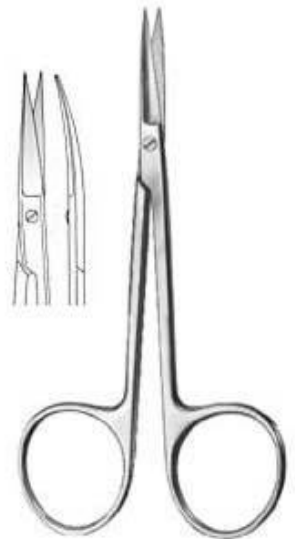

Iris Scissors

BS-5-302-10

Iris Scissors
10 cm



Iris Scissors

BS-5-303-10

Iris Scissors
10 cm



Bonn

BS-5-304-09

Iris Scissors



Dean

BS-5-278-17

Tonsil Scissors 17.5cm
17.5 cm



Spencer Scissor

BS-0-

Spencer Scissor



Dressing & Tissue Forceps



Standard

BS-5-401-10

Dressing Forceps

18.5 cm , 18.5 cm , 13cm, 14.5 cm , 16 cm, 18 cm,
20cm, 23 cm , 25 cm , 30.5 cm



Standard

BS-5-402-11

Dressing Forceps

12 cm, 13cm, 14.5 cm , 16 cm, 18 cm, 20cm, 25
cm , 30 cm



Dressing Forceps

BS-5-403-13

Dressing Forceps

13cm, 14.5 cm



Stille

BS-5-404-15

Dressing Forceps

15 cm



Mini-Adson

BS-5-405-12

Dressing Forceps

12 cm



Adson

BS-5-406-12

Dressing Forceps

12 cm, 15 cm



Dressing & Tissue Forceps



McIndoe

BS-5-405-12

Dressing Forceps
15 cm



Waugh

BS-5-408-20

Dressing Forceps
20cm



Semken

BS-5-409-12

Dressing Forceps
12.5 cm, 15 cm



Taylor

BS-5-410-17

Dressing Forceps
12.5 cm, 15 cm



Taylor

BS-5-411-17

Dressing Forceps
17 cm



Taylor

BS-5-412-17

Dressing Forceps
18.5 cm



Dressing & Tissue Forceps



Dressing Forceps

BS-5-413-06

Dressing Forceps
15.5 cm



Gerald

BS-5-414-18

Dressing Forceps
15.5 cm



Cushing

BS-5-415-17

Dressing Forceps
17.5 cm



Potts-Smith

BS-5-416-18

Dressing Forceps
18 cm, 21cm, 24.5 cm



Bonney

BS-5-417-17

Dissecting Forceps
17.5 cm



Gerald

BS-5-418-17

17.5 cm



Dressing & Tissue Forceps



Gillies

BS-5-419-15

Dissecting Forceps
15.5 cm



McIndoe

BS-5-420-15

Dissecting Forceps
15 cm



Semken

BS-5-421-16

Dissecting Forceps
15.5 cm, 17.5 cm



Adson-Brown

BS-5-422-12

Dissecting Forceps
12 cm



Adson

BS-5-423-12

Dissecting Forceps
12 cm, 15 cm



Adson

BS-5-424-12

Dressing Forceps
12 cm, 15 cm



Dressing & Tissue Forceps



Cushing

BS-5-425-17

Dressing Forceps
17.5 cm



Cushing

BS-5-426-18

Dressing Forceps
17 cm



Cushing-Taylor

BS-5-427-18

Dressing Forceps
18.5 cm



Potts-Smith

BS-5-428-15

Dressing Forceps
16 cm, 18.5 cm, 20cm, 23 cm, 25 cm



Oehler

BS-5-429-14

Dissecting Forceps
14.5 cm, 16 cm, 18 cm, 20cm, 25 cm



Wangensteen

BS-5-430-15

Dressing Forceps
15 cm, 23 cm

Dressing & Tissue Forceps



DeBakey

BS-5-421-16

Atraumatic Dressing Forceps
16 cm, 20cm, 24.5 cm



DeBakey

BS-5-432-16

Atraumatic Dressing Forceps
16 cm, 20cm, 24 cm

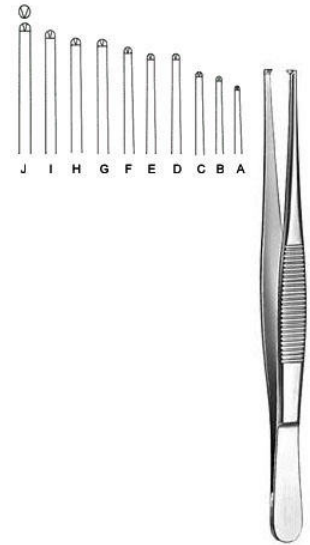

Dissecting Forceps

BS-5-433-10

Dissecting Forceps
10.5 cm , 11.5cm, 13 cm , 14.5 cm , 16 cm, 18 cm,
20cm, 23 cm , 25 cm , 30.5 cm

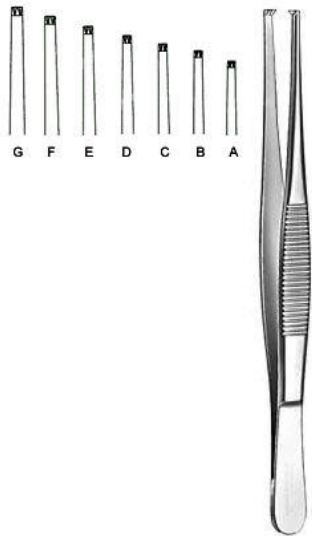

Dissecting Forceps

BS-5-434-11

Dissecting Forceps
12 cm, 13 cm , 14.5 cm , 15.5 cm, 18 cm, 20cm,
24.5 cm



Dissecting Forceps

BS-5-435-14

Dissecting Forceps
14.5 cm , 16 cm



Dissecting Forceps

BS-5-436-14

Dissecting Forceps
14.5 cm , 16 cm



Dressing & Tissue Forceps



Dissecting Forceps

BS-5-437-13

Dissecting Forceps
13 cm , 14.5 cm , 16 cm, 20cm



Dissecting Forceps

BS-5-438-13

Dissecting Forceps
13 cm , 14.5 cm



Stille

BS-5-439-15

Dissecting Forceps
15 cm



Stille

BS-5-440-15

Dissecting Forceps
15 cm



Stone

BS-5-441-15

Dissecting Forceps
15 cm



Lerche

BS-5-442-15

Dissecting Forceps
15 cm

Dressing & Tissue Forceps



Adlerkreutz

BS-5-443-15

Dissecting Forceps

15.5 cm, 20.5 cm, 16 cm, 20cm, 25 cm

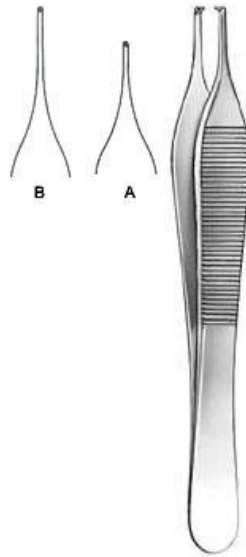

Adson

BS-5-444-12

Dissecting Forceps

12 cm, 15 cm



Gillies

BS-5-445-15

Dissecting Forceps

15.5 cm



Waugh

BS-5-446-20

Dissecting Forceps

20.5 cm



Semken

BS-5-447-12

Dissecting Forceps

12.5 cm, 15 cm



Taylor

BS-5-448-17

Dissecting Forceps

17.5 cm

Dressing & Tissue Forceps



Taylor

BS-5-449-17

Dissecting Forceps
17 cm



Taylor

BS-5-450-17

Dissecting Forceps
18.5 cm



Dissecting Forceps

BS-5-451-06

Dissecting Forceps
15.5 cm



Gerald

BS-5-452-17

Dissecting Forceps
17.5 cm



Cushing

BS-5-453-17

Dissecting Forceps
18 cm



Potts-Smith

BS-5-454-18

Dissecting Forceps
18 cm, 21 cm, 24 cm



Dressing & Tissue Forceps

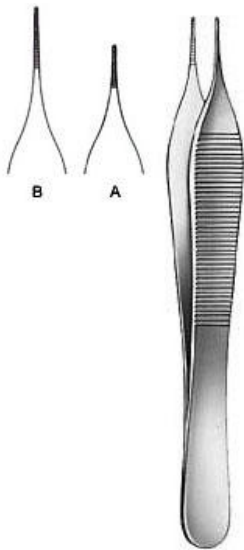

Mikro-Adson

BS-5-455-12

Dressing Forceps
12 cm, 15 cm

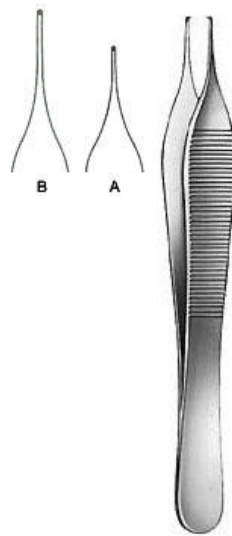

Mikro-Adson

BS-5-456-12

Dissecting Forceps
12 cm, 15 cm



Dissecting Forceps

BS-5-457-11

Dissecting Forceps
10.5 cm



Micro Jewelers

BS-5-458-12

Jeweler Type Forceps
12 cm Fig. 7



Jewelers

BS-5-459-12

Jeweler Type Forceps
12 cm Fig. 3



Jewelers

BS-5-460-11

Jeweler Type Forceps
11 cm Fig. 3c



Dressing & Tissue Forceps



Jewelers

BS-5-461-11

Jeweler Type Forceps
11 cm Fig. 5



Jewelers

BS-5-462-11

Jeweler Type Forceps
11 cm Fig. 4



Stille-Barraya

BS-5-463-18

Dissecting Forceps
18 cm



Bonney

BS-5-464-18

Dissecting Forceps
17.5 cm



Nelson

BS-5-465-23

Dissecting Forceps
23 cm



Dressing Forceps

BS-5-466-10

Dressing Forceps
10 cm , 9.5 cm



Dressing & Tissue Forceps



Splinter Forceps Smooth Jaw

BS-5-467-12

Splinter Forceps smooth jaw
12.5 cm



Splinter Forceps Smooth Jaw

BS-5-468-12

Splinter Forceps smooth jaw
12.5 cm



Splinter Forceps

BS-5-469-12

Splinter Forceps
12.5 cm



Splinter Forceps

BS-5-470-12

Splinter Forceps
12.5 cm



Micro Tying Forceps

BS-5-471-16

Micro Tying Forceps
15.5 cm



**Microscopic Forceps Super Light,
Blunt**

BS-5-472-10

Microscopic Forceps super light, blunt
10 cm



Dressing & Tissue Forceps



Microscopic Forceps

BS-5-473-10

Microscopic Forceps
10 cm



Shaaf

BS-5-474-09

Splinter Forceps
9.5 cm



Littauer

BS-5-475-08

Cilia Forceps
8.5 cm



Cilia Forceps

BS-5-476-09

Cilia Forceps
8.5 cm



Douglas

BS-5-477-09

Cilia Forceps
9 cm



Douglas

BS-5-478-09

Cilia Forceps
9 cm



Beer

BS-5-479-09

Cilia Forceps

9 cm



Splinter Forceps



Phaneuf

BS-5-501-21

Hysterectomy Forceps
20.5 cm



Wertheim-Cullen

BS-5-502-21

Vaginal Clamp
21 cm

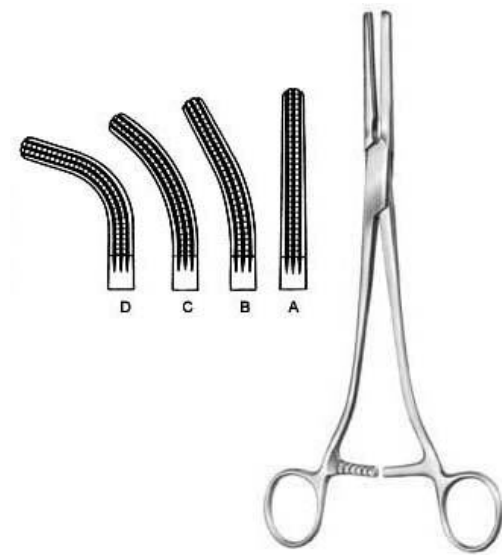

Rogers

BS-5-503-10

Hysterectomy Forceps
21.5 cm Fig. 1, 21 cm Fig. 2, 20.5 cm Fig. 3, 20 cm Fig. 4



Moynihan

BS-5-504-23

Hysterectomy Forceps
23 cm



Moynihan

BS-5-505-24

Hysterectomy Forceps
23.5 cm



Wertheim

BS-5-506-25

Hysterectomy Forceps
26 cm



Splinter Forceps

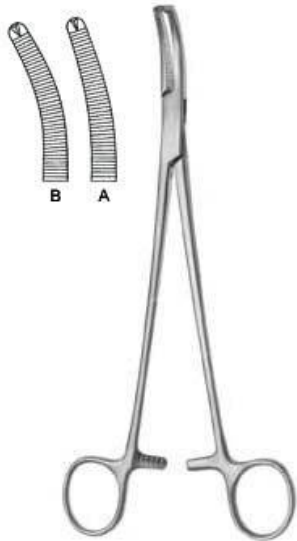

Wertheim

BS-5-507-22

Hysterectomy Forceps
22.5 cm



Mikulicz, Baby

BS-5-508-14

Peritoneum Forceps
14.5 cm



Mikulicz

BS-5-509-18

Peritoneum Forceps
20.5 cm



Mikulicz

BS-5-510-20

Peritoneum Forceps
18.5 cm



Mikulicz

BS-5-511-20

Peritoneum Forceps
20cm



Mikulicz

BS-5-512-21

Peritoneum Forceps
20.5 cm

Splinter Forceps



Faure

BS-5-513-20

Peritoneum Forceps

21 cm

Haemostatic Forceps

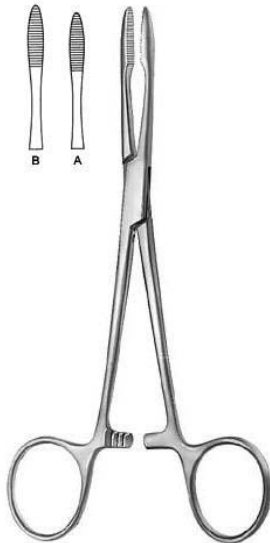

Pean

BS-5-601-14

Haemostatic Forceps
14.5 cm , 16 cm

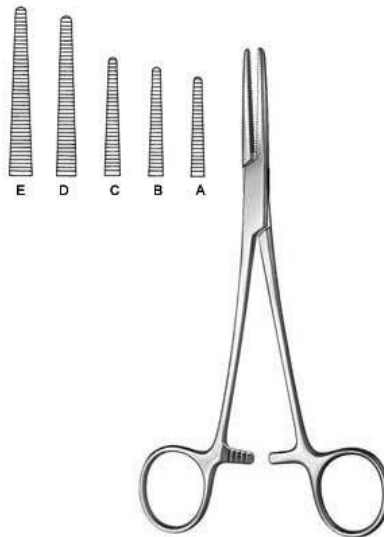

Spencer-Wells

BS-5-602-13

Haemostatic Forceps
13 cm , 14 cm, 15.5 cm, 18.5 cm , 20 cm

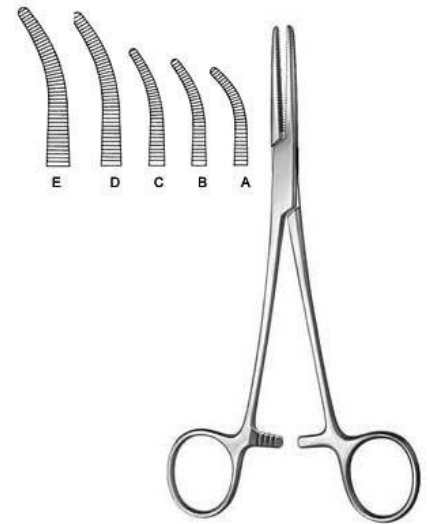

Spencer-Wells

BS-5-603-13

Haemostatic Forceps
13 cm , 14 cm, 15 cm, 18 cm, 20 cm



Chaput

BS-5-604-13

Haemostatic Forceps
12.5 cm



Tuffier

BS-5-605-13

Haemostatic Forceps
12.5 cm

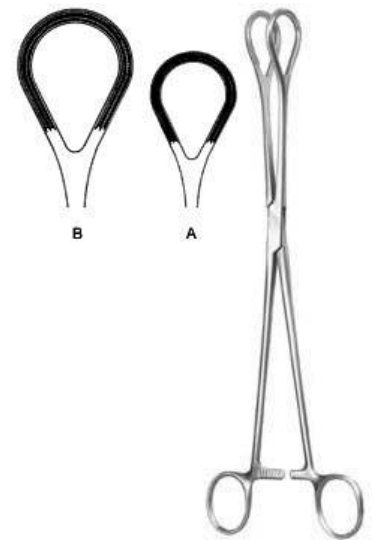

Graspings Forceps

BS-5-606-25

Organ Graspings Forceps



Haemostatic Forceps



Collin

BS-5-607-14

Organ Grasping Forceps
12.5 cm, 21 cm



Collin

BS-5-608-17

Tumor Grasping Forceps
17 cm



Pennington

BS-5-609-15

Haemostatic Forceps
15.5 cm



Pratt

BS-5-610-15

Haemostatic Forceps
15 cm



Martel-Rees

BS-5-611-14

Face-lift Forceps
13.5 cm



Ligature Forceps

BS-5-612-12

Ligature Forceps

Haemostatic Forceps

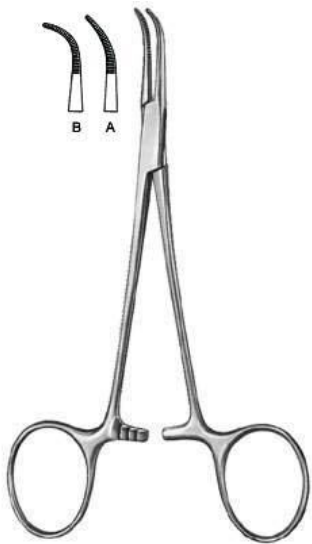

Mixer-Baby

BS-5-613-01

Dissecting and Ligature Forceps
13 cm , 13.5 cm

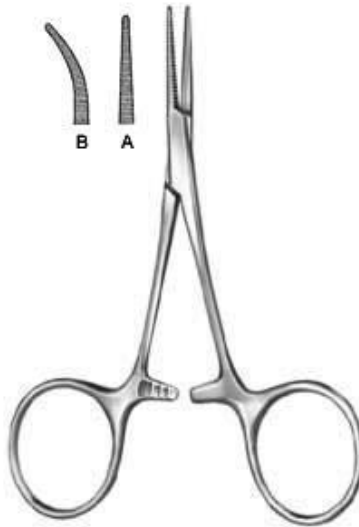

Hartmann

BS-5-614-10

Haemostatic Forceps
9.5 cm, 10 cm



Ligature Forceps

BS-5-615-12

Ligature Forceps

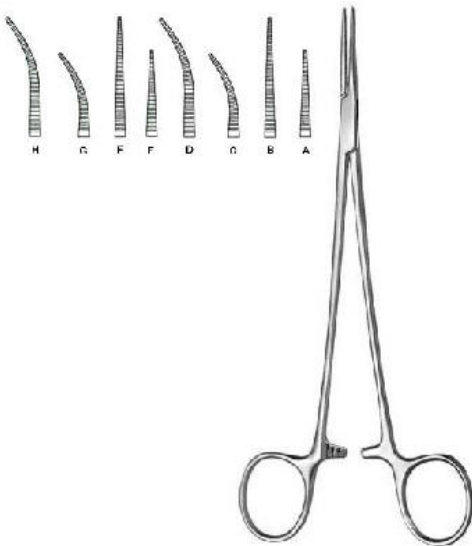

Halsted-Mosquito

BS-5-616-18

Haemostatic Forceps
12.5 cm, 14 cm, 14.5 cm

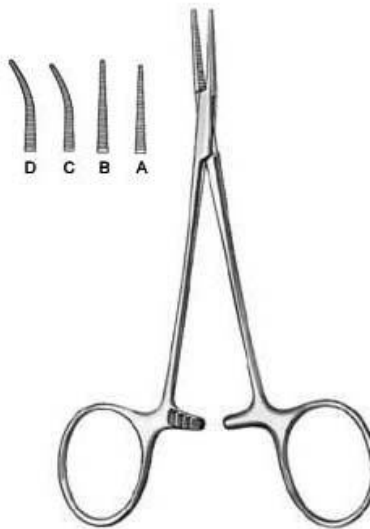

Mikro-Mosquito

BS-5-617-10

Haemostatic Forceps
9.5 cm, 10 cm , 11.5 cm, 12 cm

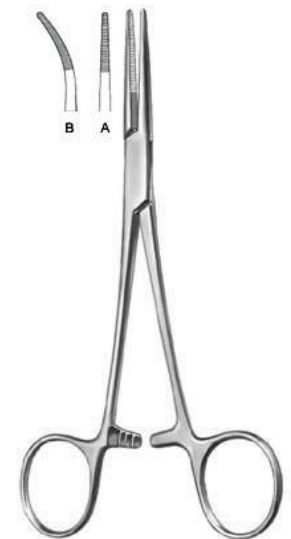

Providence-Hospital

BS-5-618-14

Haemostatic Forceps
14 cm

Haemostatic Forceps



Leriche

BS-5-619-15

Haemostatic Forceps
15 cm, 15.5 cm

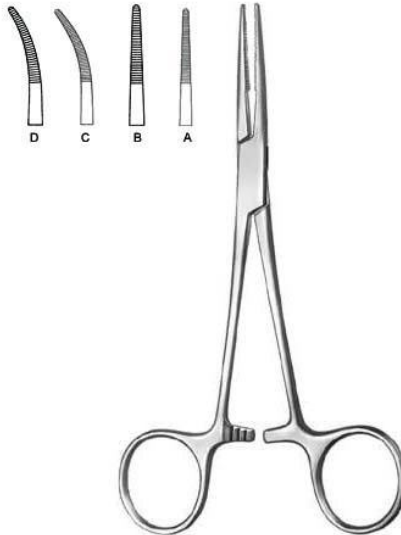

Kelly

BS-5-620-14

Haemostatic Forceps
14 cm, 14.5 cm

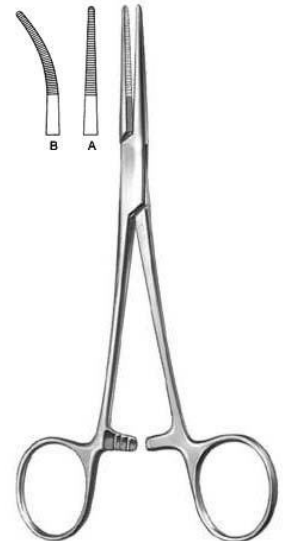

Kelly-Rankin

BS-5-621-16

Haemostatic Forceps
15.5 cm, 16 cm



Overholt-Baby

BS-5-622-14

Dissecting and Ligature Forceps
14 cm, 14.5 cm



Crile

BS-5-623-14

Haemostatic Forceps
14 cm, 14.5 cm



Crile-Rankin

BS-5-624-16

Haemostatic Forceps
16 cm, 16.5 cm



Haemostatic Forceps

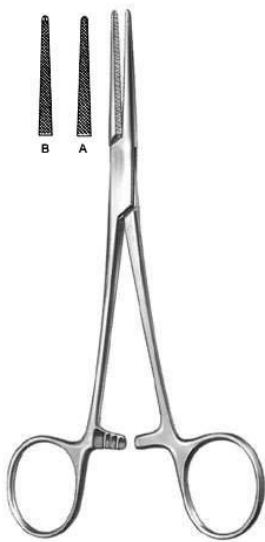

Lovelace

BS-5-625-15

Haemostatic Forceps
16 cm



Dandy-Mosquito

BS-5-626-12

Haemostatic Forceps
12 cm

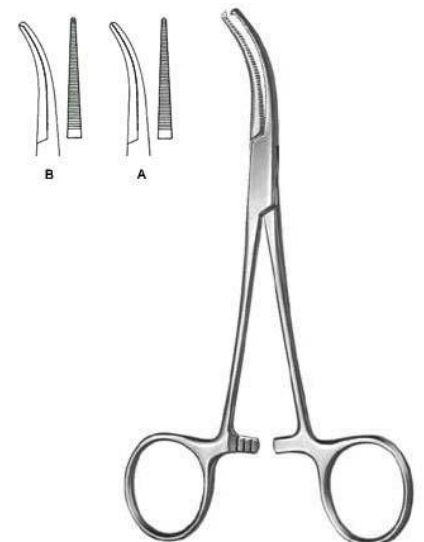

Dandy

BS-5-627-14

Haemostatic Forceps
14 cm, 14.5 cm



Schidt

BS-5-628-18

Dissecting and Ligature Forceps
18.5 cm, 19 cm



Adson

BS-5-629-18

Dissecting and Ligature Forceps
18.5 cm, 19 cm



Martin-Fuchsig

BS-5-630-20

Dissecting and Ligature Forceps
20.5 cm

Haemostatic Forceps

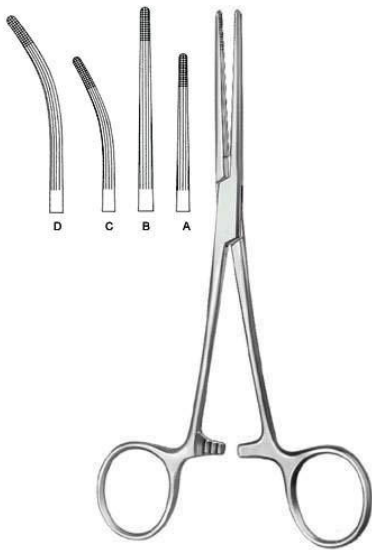

Rochester-Carmalt

BS-5-631-16

Haemostatic Forceps
16.5 cm, 17 cm, 20 cm, 20.5 cm

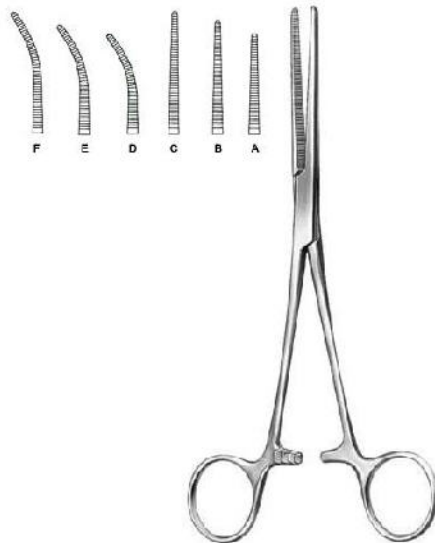

Pean

BS-5-632-13

Haemostatic Forceps
13 cm, 13.5 cm, 14 cm, 14.5 cm, 16.5 cm, 17 cm

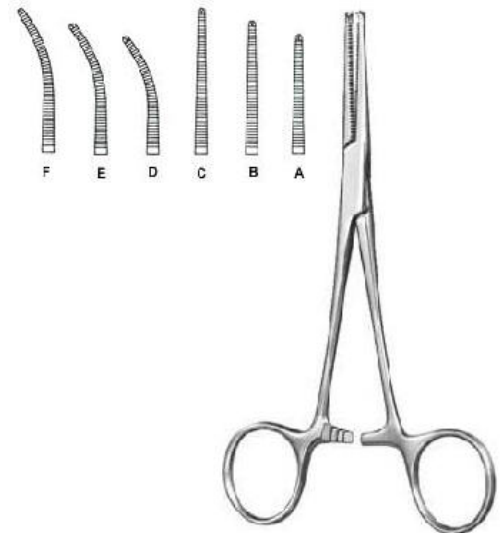

Kocher-Nippon

BS-5-633-14

Haemostatic Forceps
14.5 cm, 16 cm, 16.5 cm, 18 cm, 18 cm

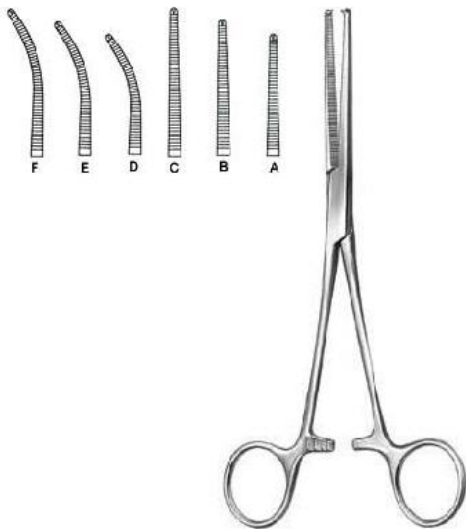

Kocher

BS-5-635-13

Haemostatic Forceps
13 cm, 14 cm, 16 cm

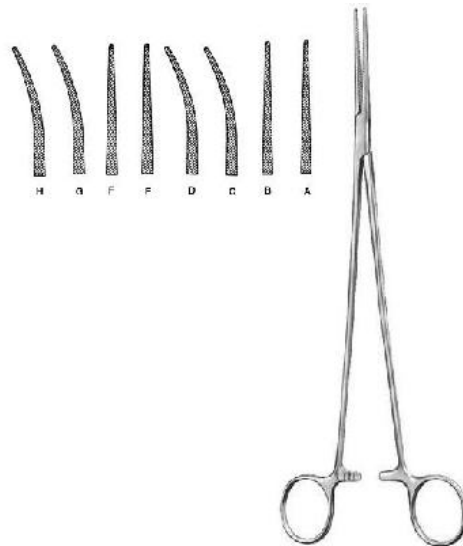

Bengolea

BS-5-636-20

Haemostatic Forceps
21 cm, 21.5 cm, 26 cm

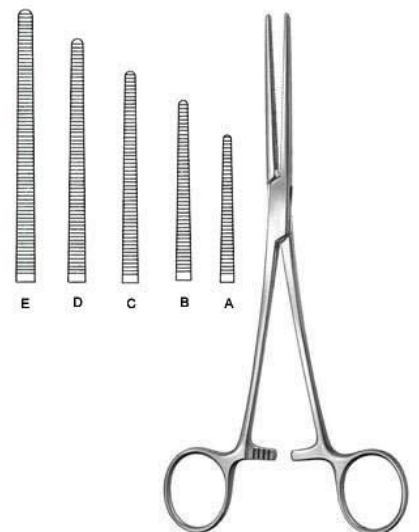

Pean (Rochester)

BS-5-637-14

Haemostatic Forceps
14 cm, 14.5 cm, 16 cm, 16.5 cm, 18.5 cm, 20.5 cm, 22.5 cm, 24.5 cm, 26 cm, 30.5 cm



Haemostatic Forceps

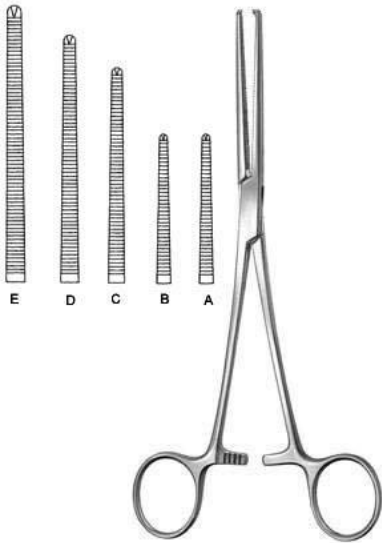

Kocher (Ochsner)

BS-5-638-14

Haemostatic Forceps

14.5 cm , 16.5 cm , 18.5 cm , 20.5 cm , 22.5 cm ,
24.5 cm , 26 cm , 30.5 cm

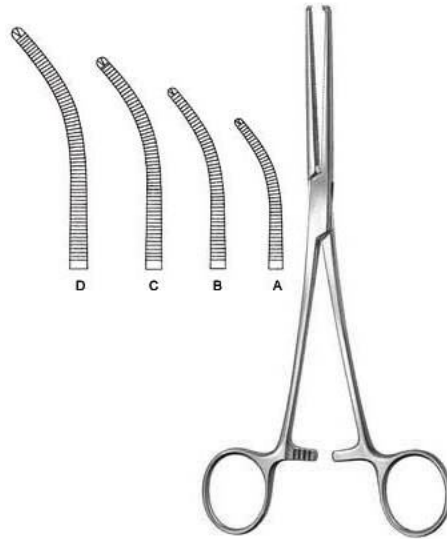

Kocher (Ochsner)

BS-5-639-14

Haemostatic Forceps

14 cm , 16 cm , 18 cm , 20 cm , 22 cm , 24 cm , 25.5
cm , 30 cm

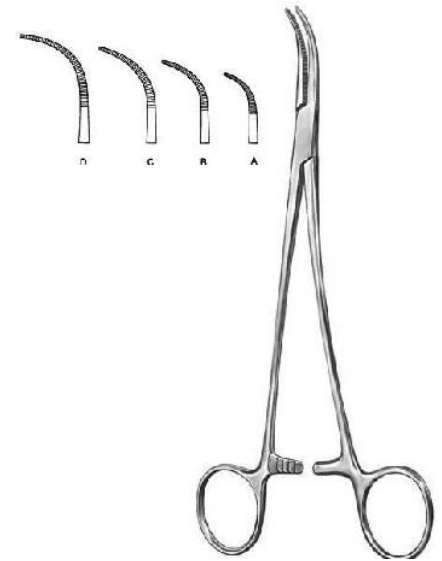

Overholt-Martin

BS-5-640-01

Dissecting and Ligature Forceps

18.5 cm Fig. 1 , 20.5 cm Fig. 2 , 21 cm Fig. 3 , 21.5
cm Fig. 4 , 24.5 cm Fig. 5



Mixer-Baby

BS-5-641-18

Dissecting and Ligature Forceps

18.5 cm



Adson-Baby

BS-5-642-14

Dissecting and Ligature Forceps

14.5 cm , 18 cm



Heiss

BS-5-643-20

Dissecting and Ligature Forceps

20 cm , 20.5 cm , 21 cm

Haemostatic Forceps



Overholt-Mixter

BS-5-644-21

Dissecting and Ligature Forceps
21.5 cm

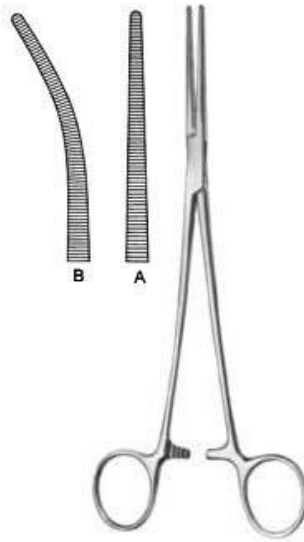

Roberts

BS-5-645-22

Dissecting and Ligature Forceps
21.5 cm, 22.5 cm

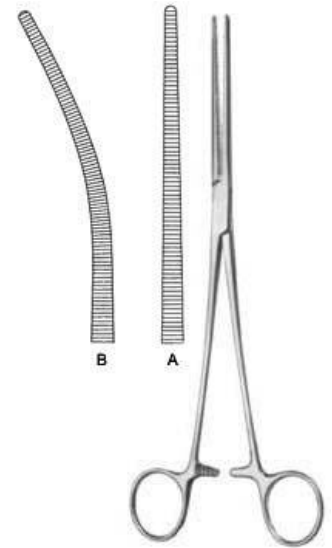

Sarot

BS-5-646-24

Dissecting and Ligature Forceps
24.5 cm, 25 cm

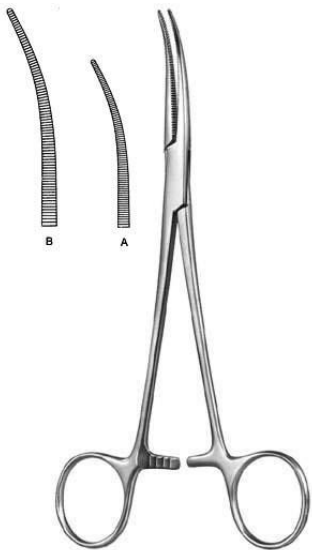

Crafoord

BS-647-18

Dissecting and Ligature Forceps
18 cm, 24.5 cm

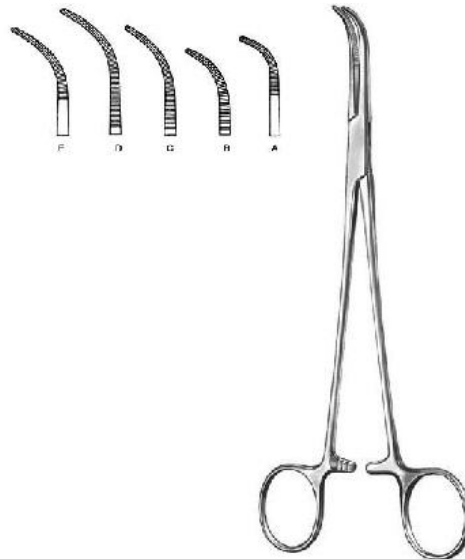

Overholt-Geissendorfer

BS-5-648-01

Dissecting and Ligature Forceps
20.5 cm Fig. 1, 20 cm Fig. 2, 21.5 cm Fig. 3, 22 cm Fig. 4, 21.5 cm Fig. 5, 22 cm Fig. 6, 27 cm Fig. 1, 26.5 cm Fig. 2, 27.5 cm Fig. 3, 28 cm Fig. 4

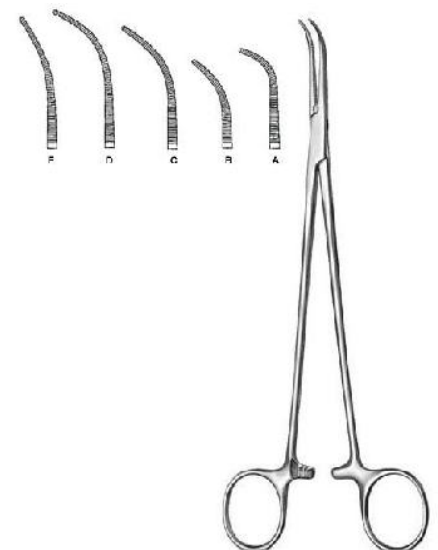

Overholt-Fino

BS-5-649-00

Dissecting and Ligature Forceps
21 cm, 21.5 cm, 22 cm, 22.5 cm, 23 cm

Haemostatic Forceps

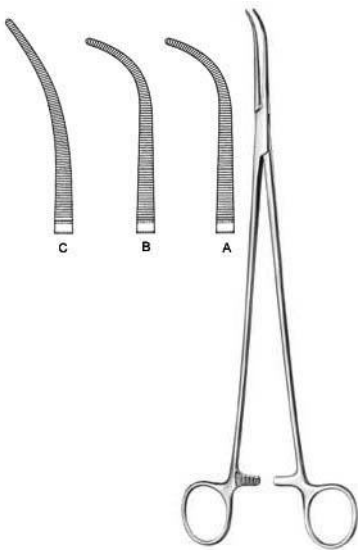

Overholt

BS-5-650-00

Dissecting and Ligature Forceps
29.5 cm, 30 cm



Overholt-Mini

BS-5-651-01

Dissecting and Ligature Forceps
15 cm, 20 cm

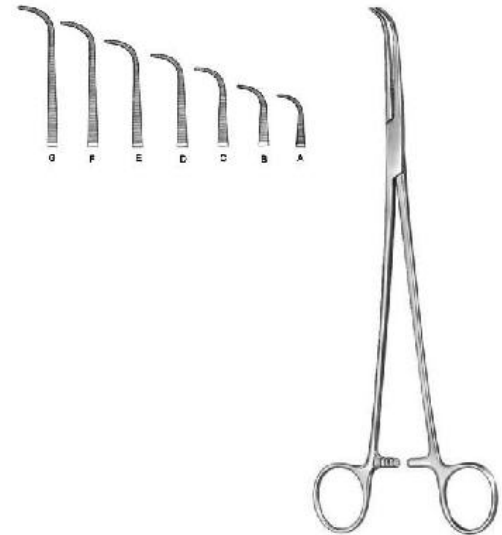

Gemini

BS-5-652-13

Dissecting and Ligature Forceps
13 cm , 16 cm, 18 cm, 21 cm, 23 cm , 25 cm , 28 cm

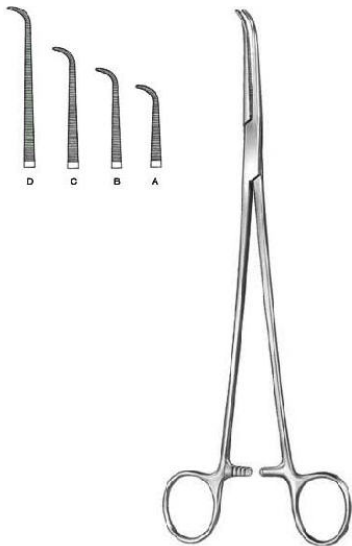

Mini-Gemini

BS-5-653-18

Dissecting and Ligature Forceps
18 cm, 22.5 cm, 25 cm , 28.5 cm

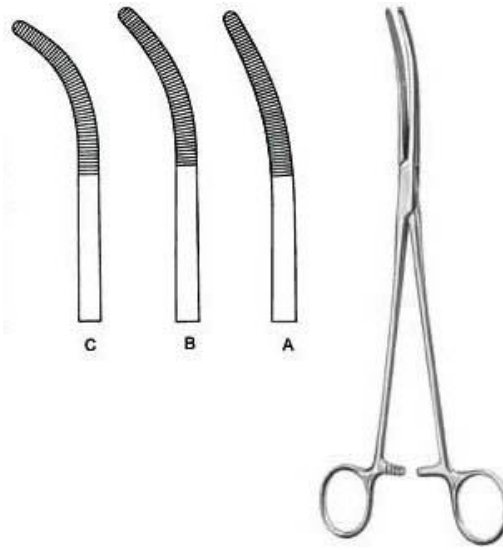

Rumel

BS-5-654-01

Dissecting and Ligature Forceps
24 cm Fig. 1 , 23.5 cm Fig. 2 , 23 cm Fig. 3, 24 cm Fig. 4 , 23.5 cm Fig. 5

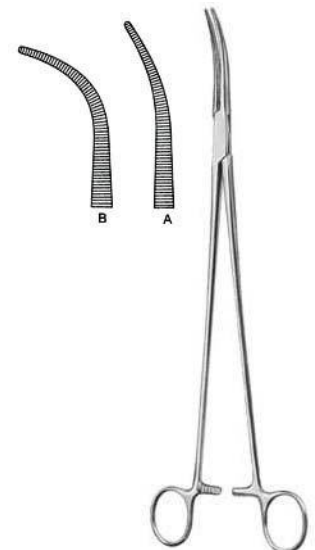

Zenker

BS-5-655-01

Dissecting and Ligature Forceps
28.5 cm, 29.5 cm

Haemostatic Forceps



Mixer-Baby

BS-5-656-14

Dissecting and Ligature Forceps
13.5 cm



Mixer

BS-5-657-15

Dissecting and Ligature Forceps
16 cm, 18 cm



Mixer-O Shaugnessy

BS-5-658-19

Dissecting and Ligature Forceps
18 cm



Mixer

BS-5-659-22

Dissecting and Ligature Forceps
22.5 cm



Mixer

BS-5-660-23

Dissecting and Ligature Forceps
23 cm

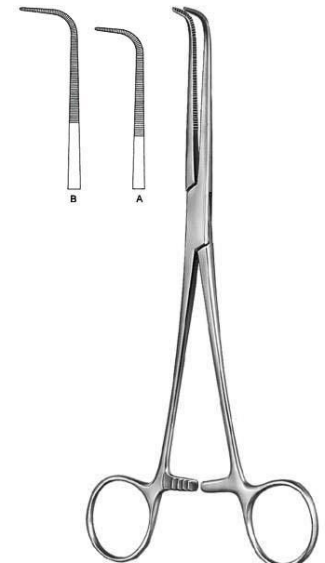

Wickstrom

BS-5-661-21

Dissecting and Ligature Forceps
21 cm, 24.5 cm



Haemostatic Forceps



Mixer

BS-5-662-22

Dissecting and Ligature Forceps
22.5 cm, 26 cm, 28 cm



Mc Quigg-Mixer

BS-5-663-22

Dissecting and Ligature Forceps
23.5 cm



Lower

BS-5-664-18

Dissecting and Ligature Forceps
18.5 cm

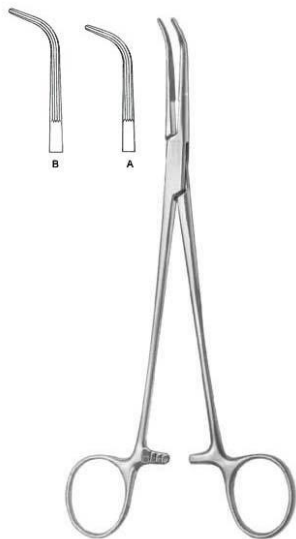

Lahey

BS-5-665-19

Bile Duct Clamp
19.5 cm, 22.5 cm



Finochietto

BS-5-666-24

Dissecting and Ligature Forceps
24 cm



Uro-Tangential

BS-5-667-01

Tangential Forceps
25 cm, 27 cm



Haemostatic Forceps

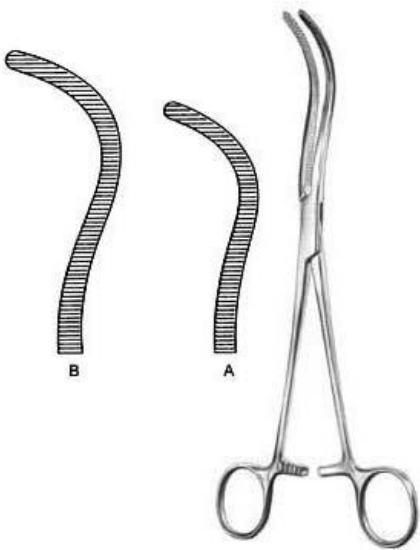

Guyon

BS-5-668-20

Kidney Pedicle Clamp
23 cm , 24 cm



Guyon

BS-5-669-23

Kidney Pedicle Clamp
19.5 cm , 21.5 cm, 24 cm



Desjardins

BS-5-670-21

Bile Duct Clamp
21 cm

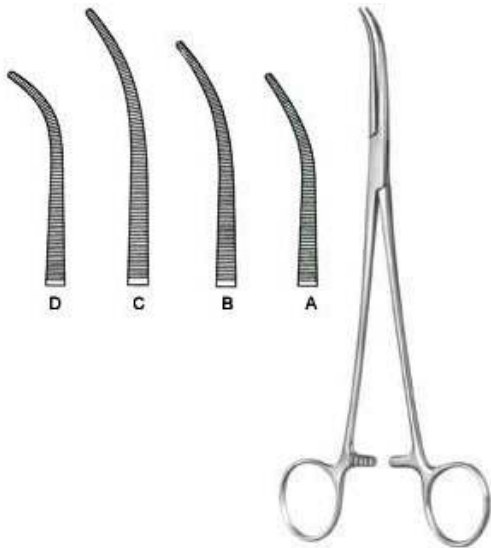

Kelly

BS-5-671-19

Dissecting and Ligature Forceps

19.5 cm Fig. 1 , 22.5 cm Fig. 1 , 24.5 cm Fig. 1 , 19 cm Fig. 2 , 22 cm Fig. 2 , 24 cm Fig. 2 , 18.5 cm Fig. 3 , 23.5 cm Fig. 3 , 21.5 cm Fig. 3



Lawrence

BS-5-672-28

Dissecting and Ligature Forceps
28 cm



Meeker

BS-5-673-28

Dissecting and Ligature Forceps
28 cm



Negus

BS-5-674-19

Haemostatic Forceps
19.5 cm Fig. 1 , 20 cm Fig. 2



Towel & Tubing Clamps



Schaedel

BS-5-701-09

Towel Clamp sharp
9 cm



Jones

BS-5-702-05

Towel Clamp sharp
5.5 cm, 8.5 cm



Jones-Martin

BS-5-703-09

Towel Clamp sharp
8.5 cm



Backhaus

BS-5-705-11

Towel Clamp
11.5 cm



Backhaus

BS-5-706-08

Towel Clamp
9 cm, 11.5 cm, 13 cm, 16 cm



Peers-Bertram Modif.

BS-5-707-15

Towel Clamp wide jaw for tube fixation
15.5 cm



Towel & Tubing Clamps



R?Der

BS-5-708-13

Towel Clamp
13.5 cm

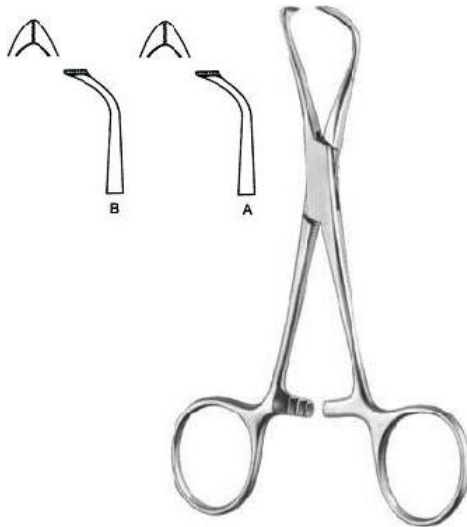

Lorna

BS-5-709-10

Towel Clamp fine serrated, wide jaw
9.5 cm, 13 cm



Bernhard

BS-5-710-16

Towel Clamp
16.5 cm

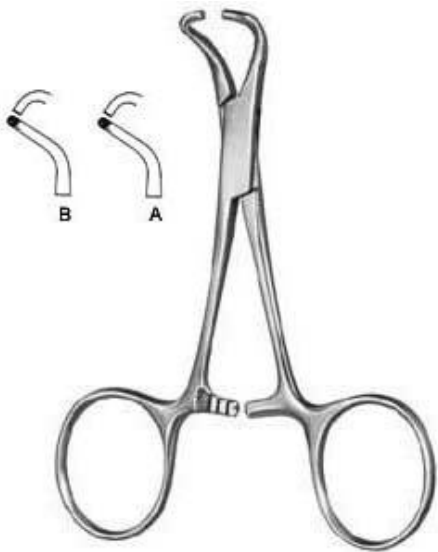

Tohoku

BS-5-711-10

Towel Clamp
10.5 cm blunt, 13.5 cm blunt, 14.5 cm

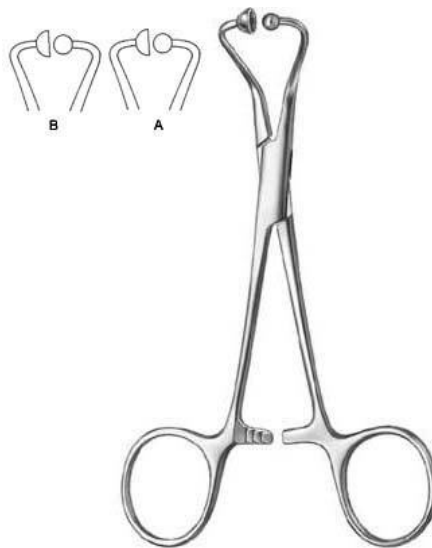

Towel Clamp For Paper Clothes

BS-5-712-11

Towel Clamp for paper clothes
11.5 cm, 14 cm



Lane

BS-5-713-20

Lane
19.5 cm

Towel & Tubing Clamps



Tube Holder For Fixation Of Six Tubes

BS-5-714-06

Tube Holder for fixation of six tubes



Tubing Clamp Extra Long Ratchet

BS-5-715-14

Tubing Clamp extra long ratchet
14 cm



Tubing Clamp

BS-5-716-16

Tubing Clamp
16.5 cm

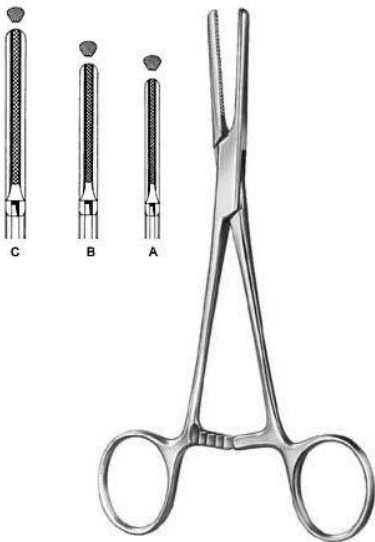

Tubing Clamp

BS-5-717-15

Tubing Clamp
15.5 cm, 19 cm, 20.5 cm

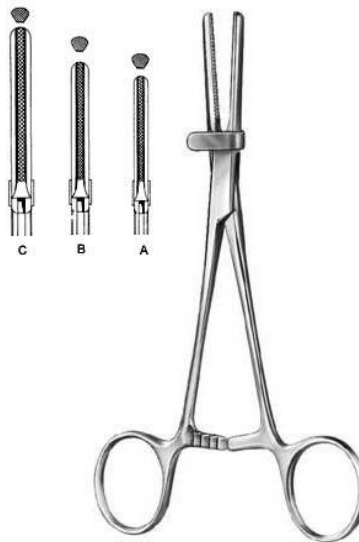

Tubing Clamp With Safety Guard

BS-5-718-15

Tubing Clamp with safety guard
15.5 cm, 19 cm, 20.5 cm

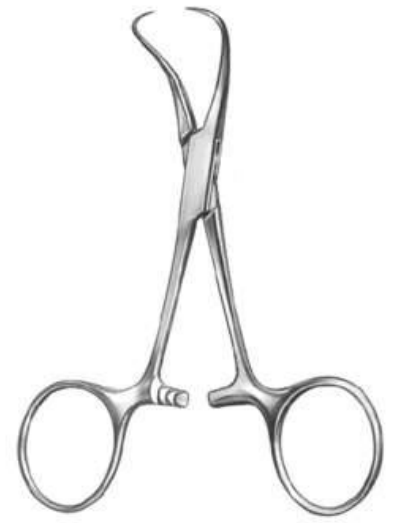

Backhaus

BS-5-704-11

Towel Clamp
11.5 cm, 13 cm

Dressing & Sponge Forceps

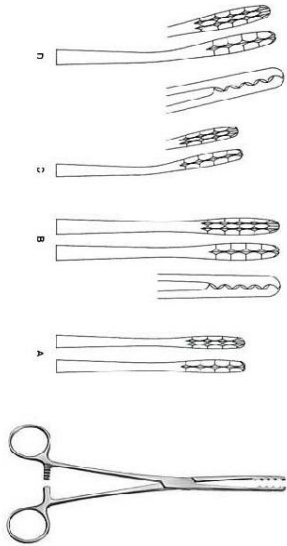

Ulrich

BS-5-801-22

Dressing Forceps
21.5 cm, 26.5 cm



Lister

BS-5-802-13

Sinus Forceps
13 cm, 16 cm, 18 cm



Martin

BS-5-803-17

Dressing Forceps
17.5 cm, 17 cm

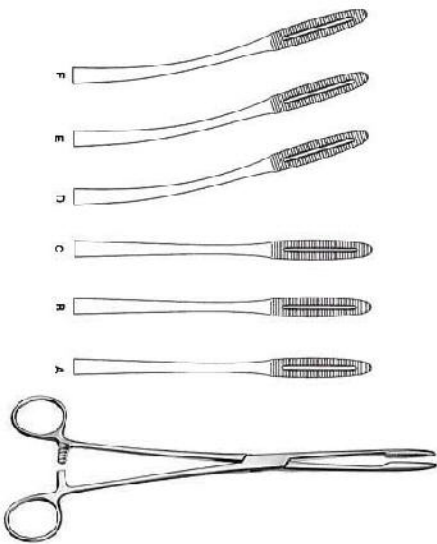

Gross-Maier

BS-5-804-20

Dressing Forceps
20.5 cm, 22 cm, 26.5 cm, 20 cm, 21.5 cm, 26 cm



Tunneling Forceps

BS-5-805-40

Tunneling Forceps
39.5 cm



Collin

BS-5-806-25

Dressing Forceps
25.5 cm

Dressing & Sponge Forceps



Cheron

BS-5-807-25

Dressing Forceps
23.5 cm



Bozemann

BS-5-808-26

Sponge Forceps
26 cm

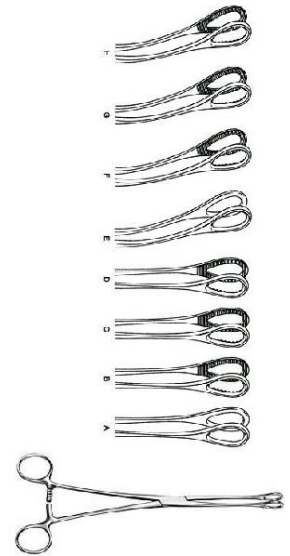

Foerster

BS-5-809-25

Sponge Forceps
25 cm , 18 cm, 20.5 cm, 24.5 cm, 17.5 cm, 20 cm,
24.5 cm

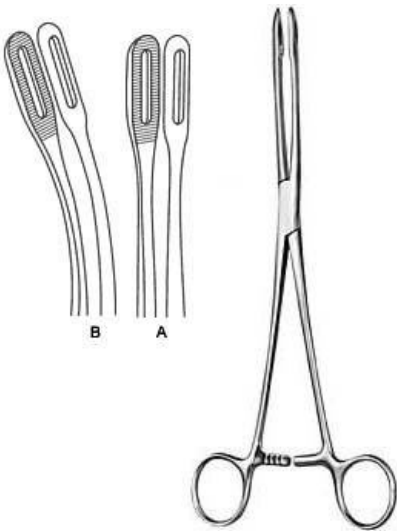

Foerster

BS-5-810-25

Sponge Forceps
25 cm , 24.5 cm

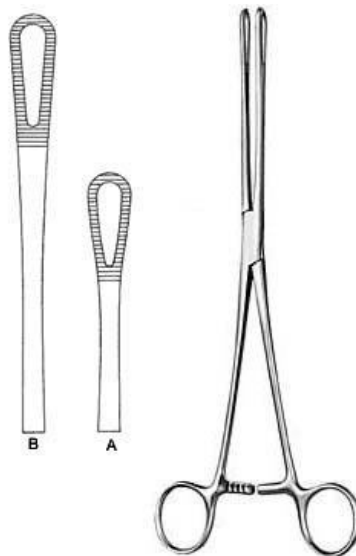

Rampley

BS-5-811-18

Sponge Forceps
18.5 cm , 24.5 cm



Vickers
BS-5-901-18
Skin Hooklet
18.5 cm



Vickers
BS-5-902-01
Bone Hooklet
17 cm



Vickers
BS-5-903-01
Tendon Hooklet
17 cm



Vickers
BS-5-904-02
Hooklet
16 cm

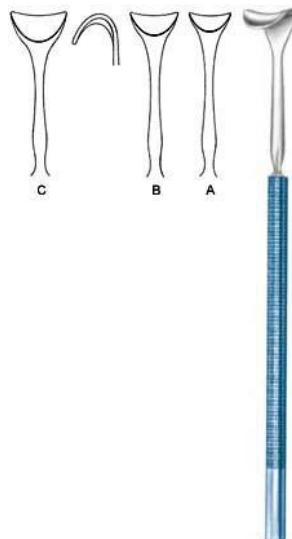

Vickers
BS-5-905-12
Saddle Hook
14 cm



Graefe
BS-5-906-01
Micro Hooklet
15 cm

Retractors

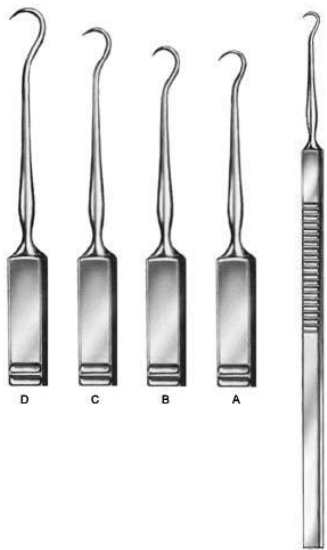

Skin Hook

BS-5-907-01

Skin Hook

16 cm Fig. 1, 16 cm Fig. 2, 16 cm Fig. 3, 16 cm Fig. 4



O Connor

BS-5-908-16

Skin Hook

16 cm

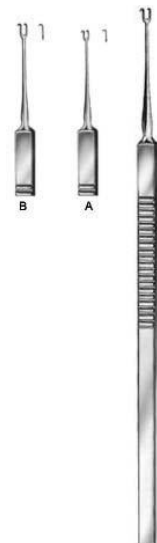

Guthrie

BS-5-909-01

Skin Hook

15.5 cm

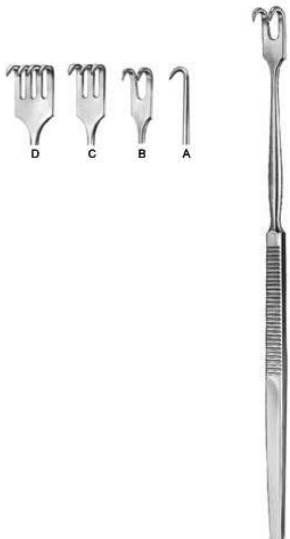

Hooklet

BS-5-910-01

Hooklet

16.5 cm



Hooklet

BS-5-911-01

Hooklet

16.5 cm



Hooklet

BS-5-912-02

Hooklet

16 cm

Retractors



Hooklet

BS-5-913-04

Hooklet
16.5 cm



Vessel Hook

BS-5-914-12

Vessel Hook
12 cm

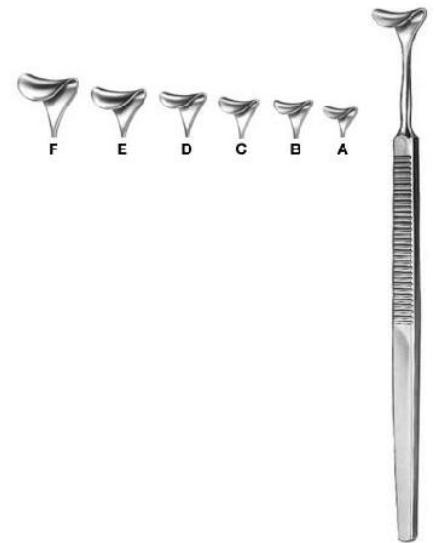

Desmarres

BS-5-915-08

Saddle Hook
16 cm 8 mm, 16 cm 10 mm, 16 cm 12 mm, 16 cm
14 mm, 16 cm 16 mm, 16 cm 18 mm

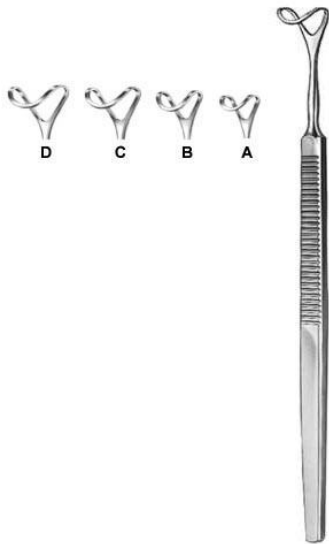

Saddle Hook

BS-5-916-12

Saddle Hook
16 cm 12 mm, 16 cm 14 mm, 16 cm 16 mm, 16
cm 18 mm

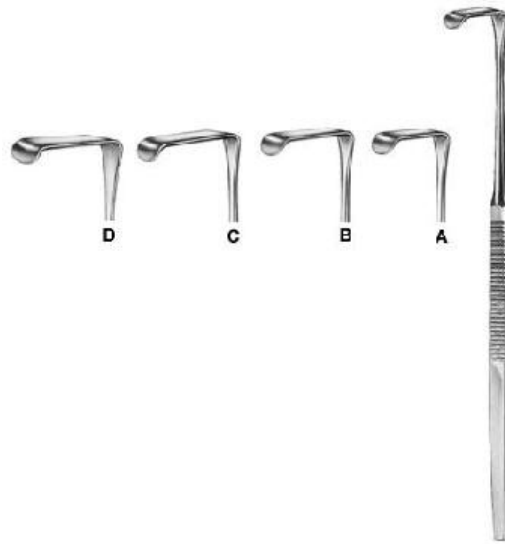

Langenbeck-Mini

BS-5-917-10

Langenbeck-Mini
16 cm



Hooklet

BS-5-918-16

Hooklet
16 cm 14 x 8



Hooklet

BS-5-919-01

Hooklet
16.5 cm



Hooklet

BS-5-920-01

Hooklet
16.5 cm



Meyerding

BS-5-921-01

Hooklet
17.5 cm Fig. 1, 17.5 cm Fig. 2, 17.5 cm Fig. 3, 17.5 cm Fig. 4, 17.5 cm Fig. 5, 17.5 cm Fig. 6



Senn-Green

BS-5-922-01

Hooklet
15 cm Fig. 1, 15 cm Fig. 2



Ragnell-Davis

BS-5-923-14

Hooklet
14 cm

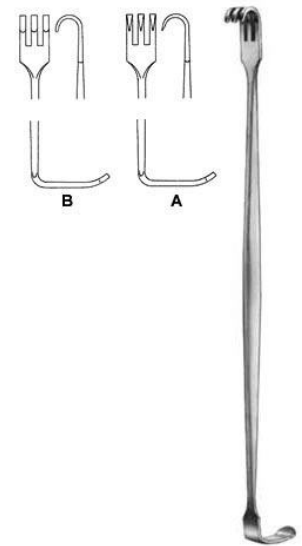

Senn-Miller

BS-5-924-16

Hooklet
16 cm

Retractors



Cushing
BS-5-925-20

Cushing
20.5 cm



Cushing
BS-5-926-08

Saddle Hook
20.5 cm 8 mm wide, 20.5 cm 10 mm wide, 20.5 cm 12 mm wide, 20.5 cm 14 mm wide, 20.5 cm 16 mm wide, 20.5 cm 18 mm wide

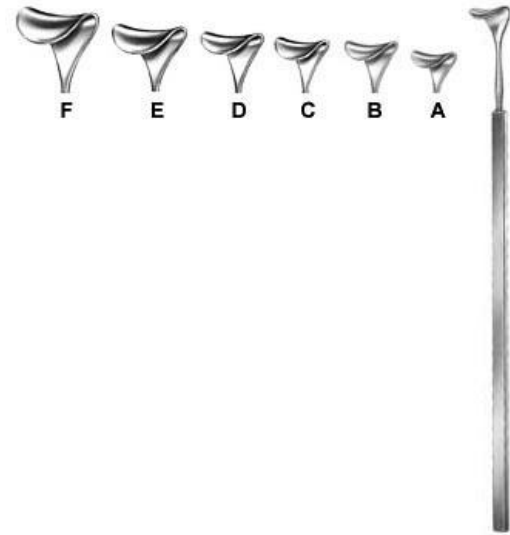

Cushing
BS-5-927-08

Saddle Hook 8 mm to 18 mm wide
24 cm



Brom
BS-5-928-01

Vein Hook
19.5 cm



Strandell-Stille
BS-5-929-01

Strandell-Stille
19 cm Fig. 1, 19 cm Fig. 2

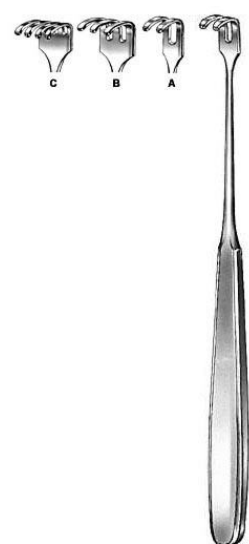

Klapp
BS-5-930-01

Retractor 12 x 6, 12 x 11, 15 x 11
17.5 cm

Retractors



Hooklet
BS-5-931-04
 Hooklet
 16.5 cm

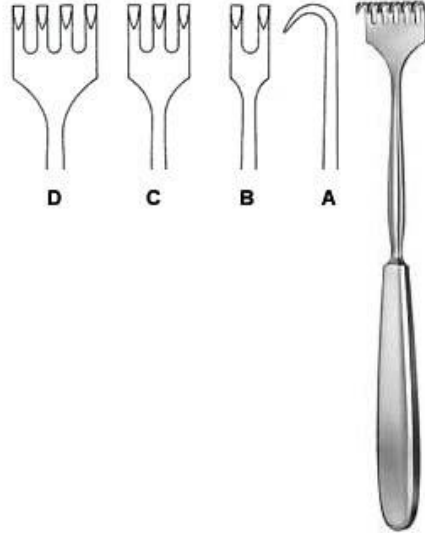

Volkmann
BS-5-932-01
 Retractor
 21.5 cm

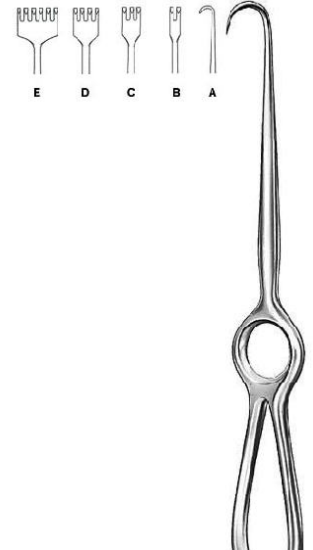

Volkmann
BS-5-933-01
 Retractor
 22 cm, 21.5 cm



Kocher
BS-5-934-01
 Retractor
 22 cm

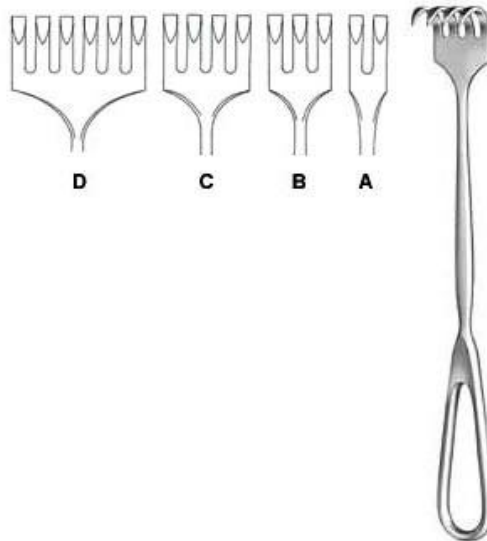

Martin
BS-5-935-02
 Retractor
 22.5 cm

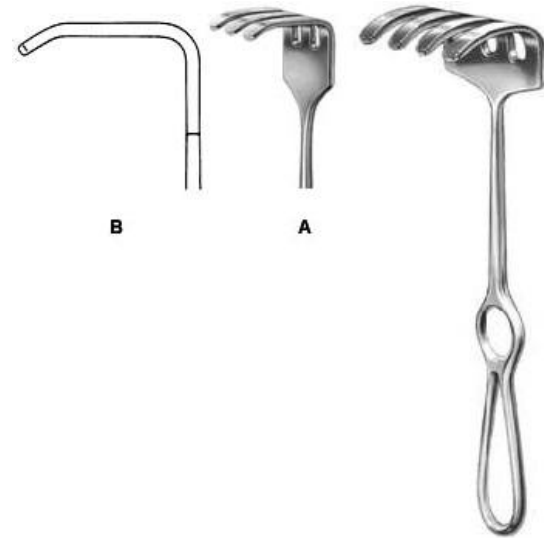

Ollier
BS-5-936-03
 Retractor
 23 cm 36 x 30, 23 cm 36 x 60

Retractors

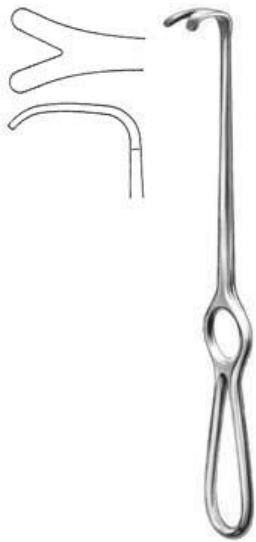

Wassmund

BS-5-937-02

Retractor
20.5 cm 33 x 21

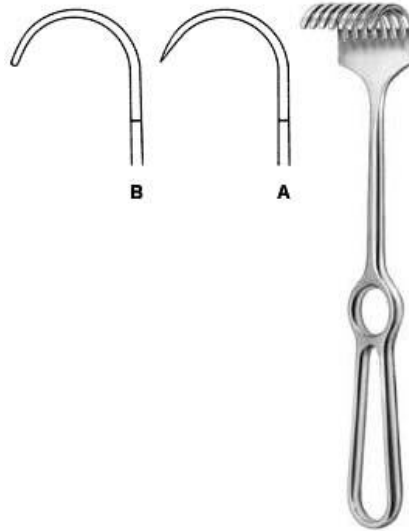

Korte

BS-5-938-08

Retractor
24.5 cm 40 x 30

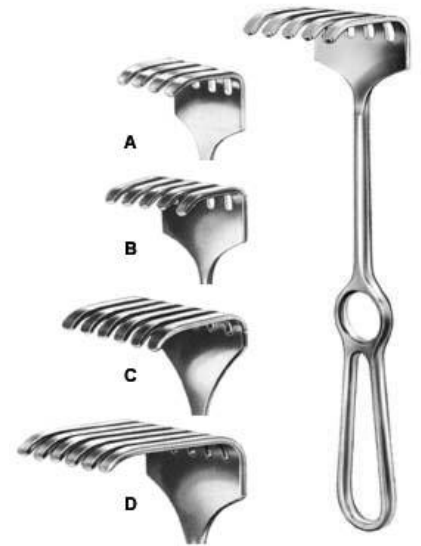

Israel

BS-5-939-04

Retractor
25.5 cm

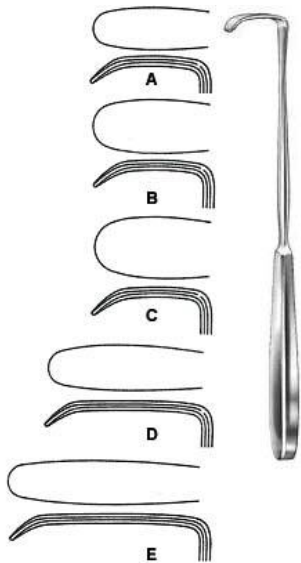

Langenbeck

BS-5-940-01

Retractor

22.5 cm 30 x 11 mm, 22.5 cm 30 x 14 mm, 22.5 cm 30 x 16 mm, 22.5 cm 40 x 11 mm, 22.5 cm 50 x 11 mm

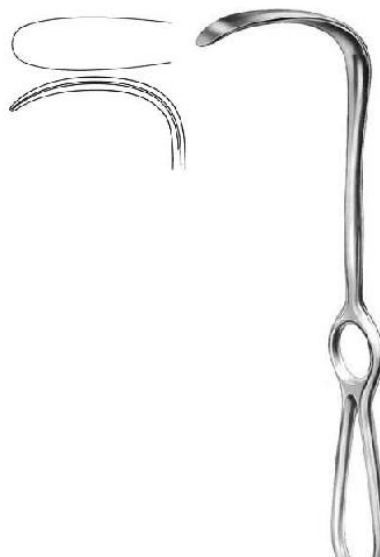

Langenbeck

BS-5-942-21

Retractor

21 cm 65 x 20 mm



Langenbeck

BS-5-943-21

Retractor

22.5 cm 85 x 15 mm

Retractors



Lahey

BS-5-944-19

Retractor

19.5 cm 36 x 19 mm



Little

BS-5-945-20

Retractor

20 cm 13 x 15 mm

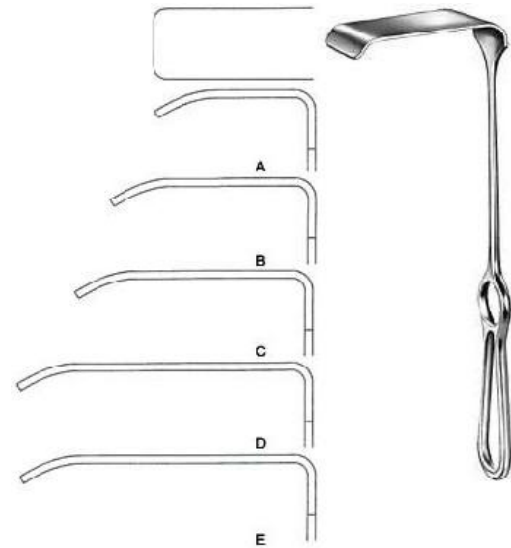

Kocher

BS-5-946-18

Retractor

23 cm 43 x 18 mm, 23 cm 53 x 20 mm, 23 cm 63 x 25 mm, 23 cm 77 x 30 mm, 23 cm 78 x 40 mm

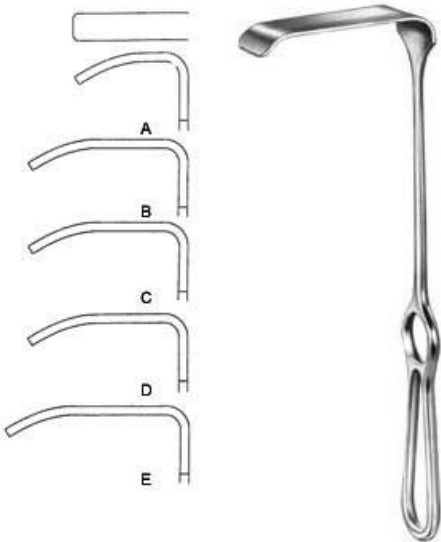

Kocher-Langenbeck

BS-5-947-01

Retractor

21.5 cm 25 x 6 mm, 21.5 cm 35 x 8 mm, 21.5 cm 35 x 11 mm, 21.5 cm 35 x 15 mm, 21.5 cm 40 x 11 mm, 21.5 cm 55 x 11 mm, 21.5 cm 70 x 14 mm, 21.5 cm 80 x 12 mm

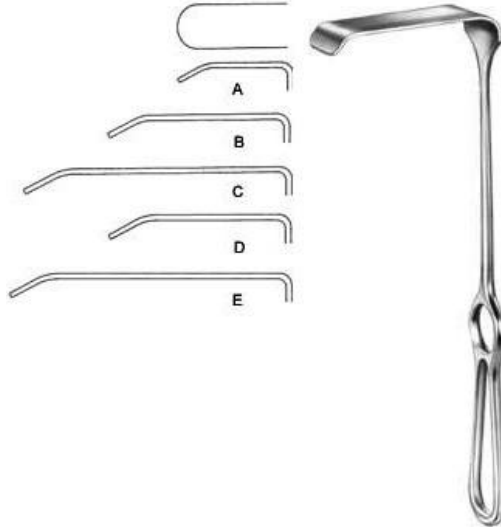

Kocher-Langenbeck

BS-5-948-01

Retractor

21.5 cm 25 x 10 mm, 21.5 cm 40 x 13 mm, 21.5 cm 60 x 13 mm, 21.5 cm 40 x 18 mm, 21.5 cm 60 x 18 mm, 21.5 cm 85 x 18 mm, 21.5 cm 60 x 25 mm, 21.5 cm 85 x 25 mm

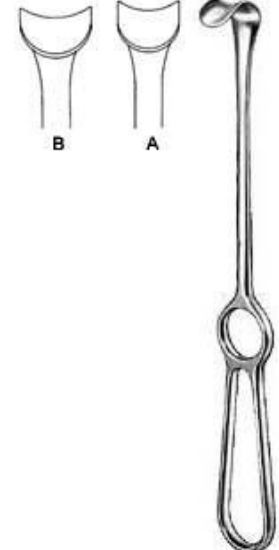

Kocher

BS-5-949-01

Retractor

21.5 cm 22 x 12, 21.5 cm 24 x 14 mm

Retractors

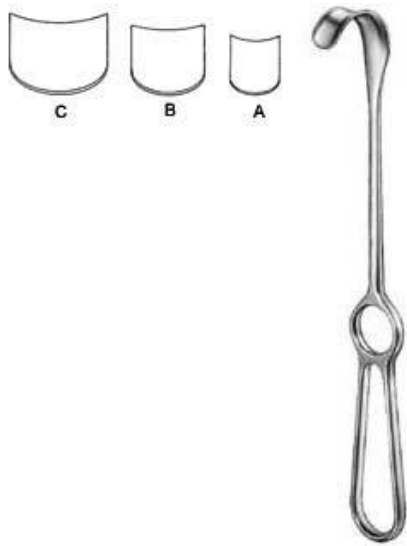

Kocher

BS-5-950-01

Retractor

22 cm 42 x 10 mm, 22 cm 42 x 15 mm, 22 cm 43 x 20 mm

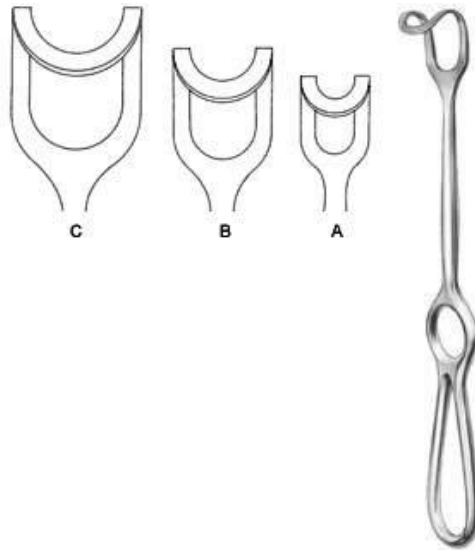

Middeldorpf

BS-5-951-01

Retractor

21.5 cm 18 x 17 mm, 23 cm 25 x 22 mm, 24.5 cm 30 x 31 mm

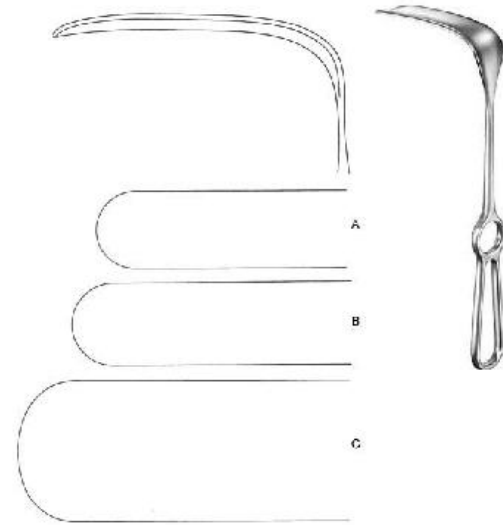

Doyen-Stille

BS-5-952-01

Retractor

26 cm 97 x 29 mm, 26 cm 101 x 31 mm, 26 cm 127 x 52 mm

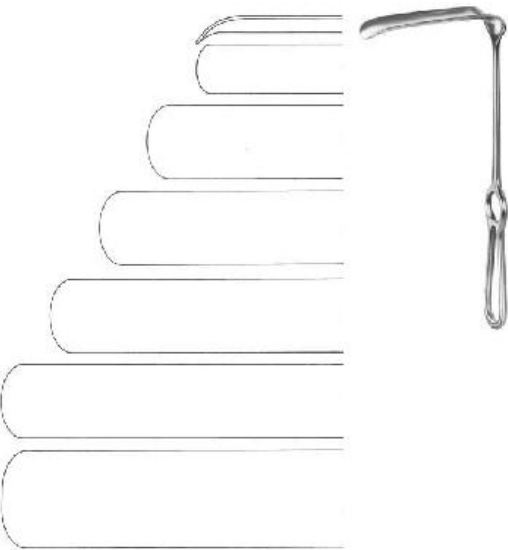

Hosel

BS-5-953-01

Retractor

26 cm 63 x 21 mm, 26 cm 83 x 30 mm, 26 cm 103 x 30 mm, 26 cm 120 x 30 mm, 26 cm 140 x 30 mm, 26 cm 140 x 40 mm

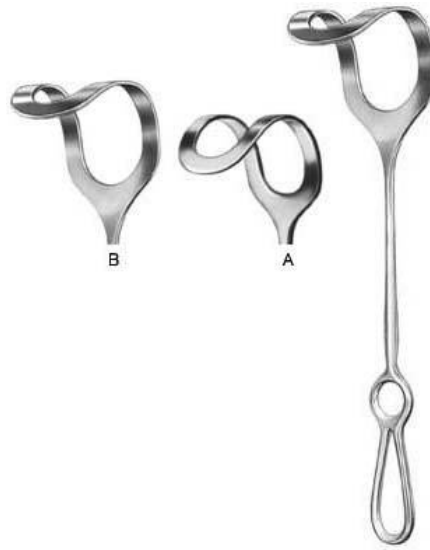

Middeldorpf

BS-5-954-01

Retractor

27 cm 48 x 45 mm, 27 cm 52 x 50 mm, 27 cm 60 x 70 mm

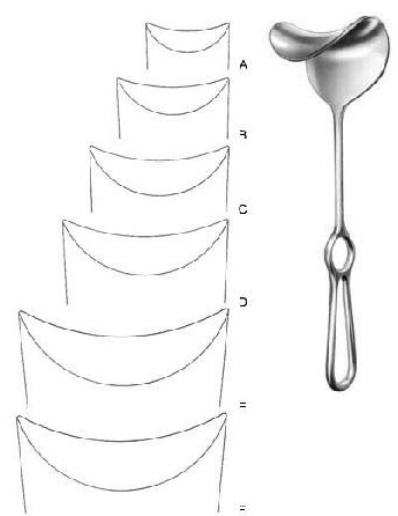

Fritsch

BS-5-955-00

Retractor

23.5 cm 37 x 31 mm, 24 cm 38 x 40 mm, 25 cm 43 x 51 mm, 25 cm 49 x 61 mm, 25.5 cm 48 x 75 mm, 25.5 cm 65 x 85 mm

Retractors



Doyen

BS-5-956-25

Retractor
24 cm 48 x 88 mm



Kocher

BS-5-957-22

Retractor
24 cm 73 x 25 mm



Kocher

BS-5-958-01

Retractor
25 cm 80 x 45 mm, 25 cm 80 x 55 mm, 25 cm 80 x 65 mm



Martin

BS-5-959-25

Retractor
26 cm 110 x 27 mm

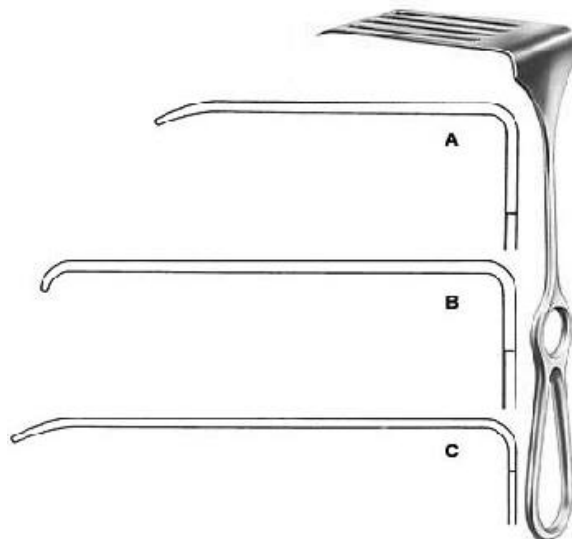

Coryllos

BS-5-960-01

Retractor
24 cm 85 x 22 mm, 24 cm 108 x 43 mm, 24 cm 119 x 65 mm



Davidson

BS-5-961-01

Retractor
19 cm 80 x 54 mm, 18.5 cm 80 x 95 mm

Retractors

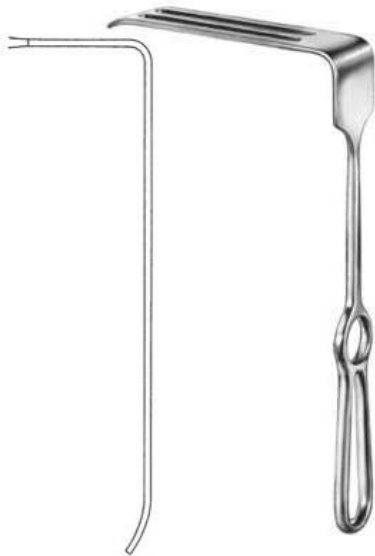

Sauerbruch

BS-5-962-25

Retractor
25.5 cm 127 x 38 mm

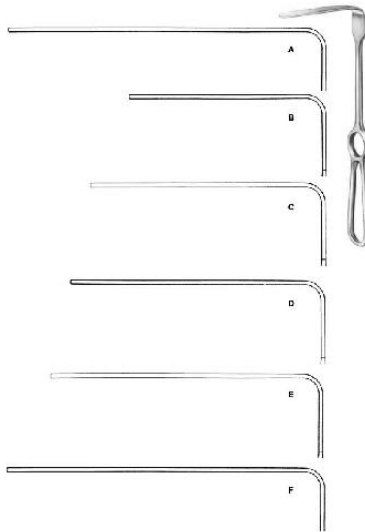

Brunner

BS-5-963-08

Retractor
25.5 cm 84 x 20 mm, 25.5 cm 104 x 25 mm, 25.5 cm 124 x 30 mm, 25.5 cm 130 x 30 mm, 25.5 cm 144 x 30 mm, 25.5 cm 160 x 30 mm, 25.5 cm 164 x 30 mm

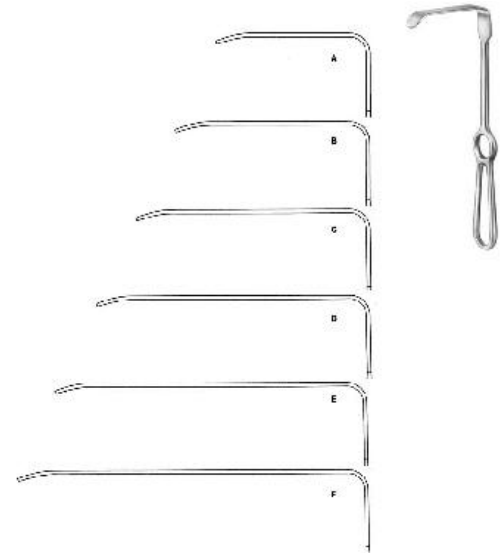

Brunner

BS-5-964-08

Retractor
25.5 cm 82 x 20 mm, 25.5 cm 102 x 20 mm, 25.5 cm 122 x 25 mm, 25.5 cm 140 x 25 mm, 25.5 cm 162 x 30 mm, 25.5 cm 182 x 30 mm

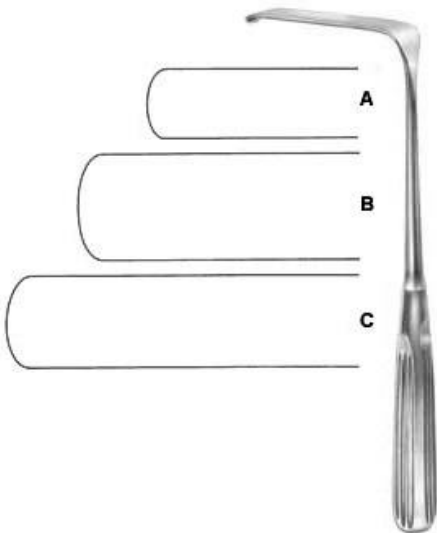

Sauerbruch

BS-5-965-01

Retractor
22.5 cm 50 x 15 mm, 22.5 cm 63 x 23 mm, 22.5 cm 80 x 20 mm



Deaver

BS-5-966-01

Retractor
18 cm 19 mm

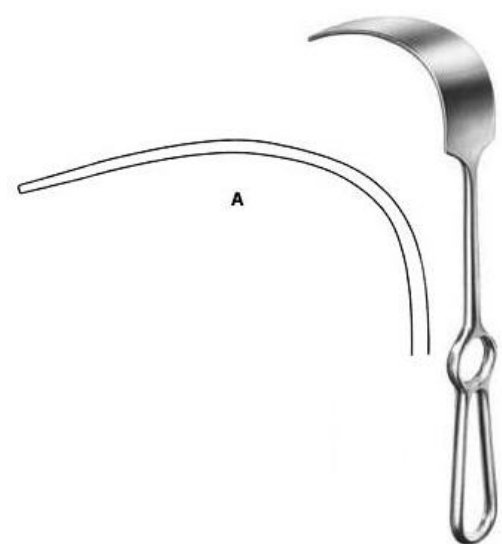

Mikulicz

BS-5-968-01

Retractor
25 cm 90 x 35 mm, 25 cm 125 x 50 mm, 25 cm 160 x 50 mm

Retractors



Mikulicz

BS-5-969-26

Retractor

26 cm 90 x 55 mm

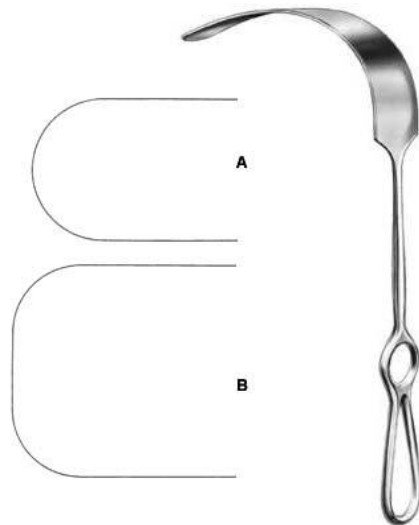

Kelly

BS-5-970-01

Retractor

27.5 cm 205 x 38 mm, 27.5 cm 205 x 57 mm



Farabeuf

BS-5-971-00

Retractor

15 cm Fig. 1 = 23 x 16, 15 cm Fig. 1 = 26 x 16, 15 cm Fig. 2 = 27 x 16, 15 cm Fig. 2 = 30 x 16

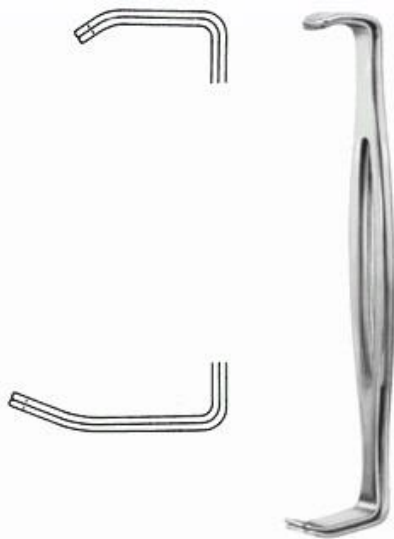

Parker-Langenbeck

BS-5-972-00

Retractor

21.5 cm Fig. 1 = 21x15 mm, 21.5 cm Fig. 1 = 40x15 mm, 21.5 cm Fig. 2 = 25x15 mm, 21.5 cm Fig. 2 = 45x15 mm



Alm

BS-5-973-07

Wound Spreaders, self-retaining

7 cm



Alm

BS-5-974-07

Wound Spreaders, self-retaining

7 cm

Retractors



Gosset

BS-5-975-22

Abdominal Retractor
18.5 cm



Balfour-Baby

BS-5-976-00

Abdominal Retractor spreading 90mm, 1 central
blade 24 x 20 mm
12.5 cm

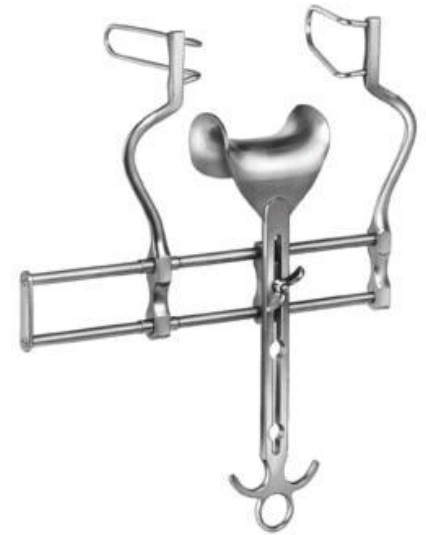

Balfour

BS-5-977-00

Abdominal retractor spreading 180 mm, lateral
blades 70 x 35 mm, 1 central blade
20 cm

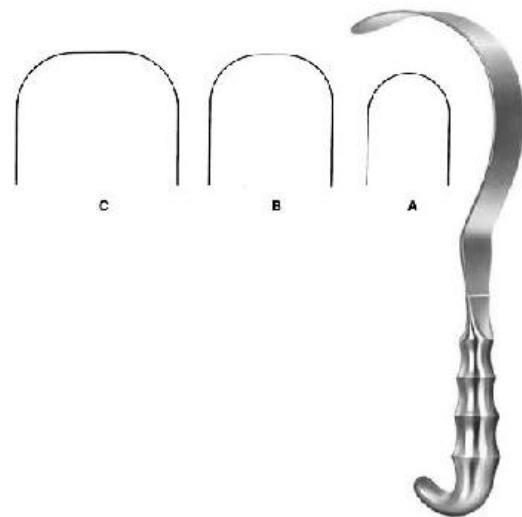

Deaver

BS-5-967-04

Retractor

31.5 cm 25 mm, 31.5 cm 38 mm, 31.5 cm 50 mm,
31.5 cm 100 mm

Probes



Probe

BS-5-1001-11

Probe

11.5cm, 13 cm , 14.5 cm , 16 cm, 18 cm, 20cm, 25 cm , 30 cm



Probe

BS-5-1002-11

Probe

11.5 cm, 13 cm , 14.5 cm , 16 cm, 18 cm, 20cm, 25 cm , 30 cm

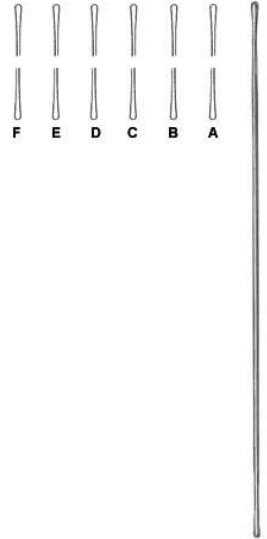

Probe

BS-5-1003-13

Probe

13 cm , 14.5 cm , 16 cm, 18 cm, 20 cm, 25 cm



Probe With Eye

BS-5-1004-13

Probe with eye

13 cm , 14.5 cm , 16 cm

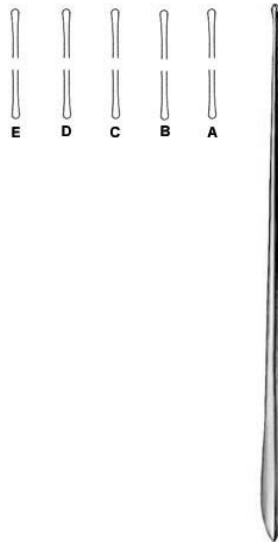

Myrtle Leaf Probe

BS-5-1006-13

Myrtle Leaf Probe

13 cm , 14.5 cm , 16 cm, 18 cm, 20 cm



Grooved Director

BS-5-1007-13

Grooved Director

13 cm , 14 cm, 16 cm



Grooved Director

BS-5-1008-13

Grooved Director
13 cm , 14.5 cm , 16 cm



Doyen

BS-5-1009-14

Grooved Director
14.5 cm



Nelaton

BS-5-1010-16

Grooved Director
16 cm

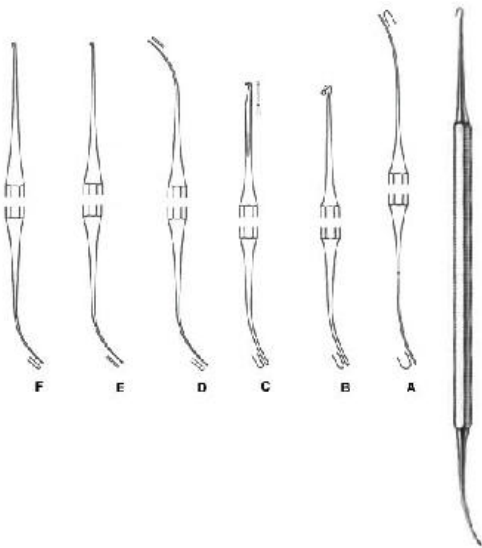

Varady

BS-5-1011-01

Phlebotomizer
18 cm, 17.5 cm

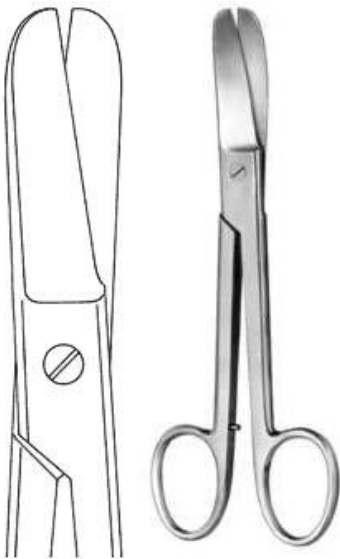

Lorenz

BS-6-101-23

Bandage Scissors heavy pattern
23 cm



Lister

BS-6-102-14

Bandage Scissors
14.5 cm , 18.5 cm , 20 cm



Bergmann

BS-6-103-23

Plaster Shears
23.5 cm



Esmarch

BS-6-104-20

Plaster Shears heavy pattern, short blades
20 cm



**Bandage Scissors Black Plastic Ring
With Autodavable**

BS-6-105-15

Bandage Scissors black plastic ring with
autodavable
16 cm, 19 cm



Bandage Scissors Black Plastic Rings

BS-6-106-18

Bandage Scissors black plastic rings
16 cm, 19 cm

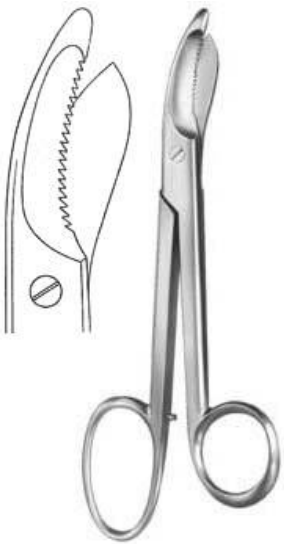

Brun's

BS-6-107-24

Plaster Scissors
24 cm



Stille-Martin

BS-6-108-23

Plaster Shears
23 cm , 27 cm, 38 cm

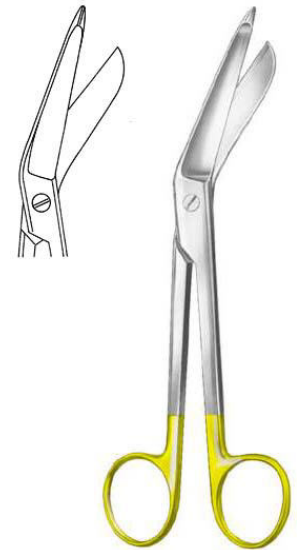

Lister

BS-6-109-18

Bandage Scissors
18 cm



Brun's

BS-6-110-24

Plaster Scissors
24 cm



Hopkins

BS-6-111-20

Plaster Knife with wooden handle
20 cm



Reiner

BS-6-112-18

Plaster Knife
18 cm



Reiner

BS-6-113-18

Plaster Knife

18 cm



Martin

BS-6-114-21

Plaster Knife with wooden handle

21 cm



Engel

BS-6-115-14

Plaster Saw

15.5 cm

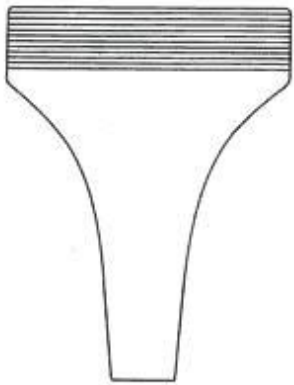

Hennig

BS-6-116-28

Plaster Spreader

28 cm



Wolff

BS-6-117-18

Plaster Breaker

18 cm, 26.5 cm



Gigli

BS-8-101-01

Wire Saw Handle



De Martel

BS-8-102-33

Wire Saw Guide
33 cm



Crutchfield

BS-8-103-01

Skull Traction Tong small pattern



Skull Traction Tong Large Pattern

BS-8-104-01

Skull Traction Tong large pattern
22.5 cm



Dahlgren

BS-8-105-20

Cranial Rongeur
20 cm



Olivecrona-Toennis

BS-8-106-14

Clip Applying Forceps



McKenzie

BS-8-107-19

Clip Applying Forceps
18.5 cm



Olivecrona

BS-8-108-18

Dura Dissector
18 cm



Olivecrona

BS-8-109-19

Dura Dissector
20 cm



Milligan

BS-8-110-21

Dura Dissector
21.5 cm



Davis

BS-8-111-21

Dura Dissector sharp
21.5 cm



Dura Dissector

BS-8-112-22

Dura Dissector
22 cm



Davis
BS--8-113
 Dura Dissector
 24.5 cm



Love
BS-8-114-19
 Nerve Root Retractor
 21.5 cm, 18 cm, 11 cm

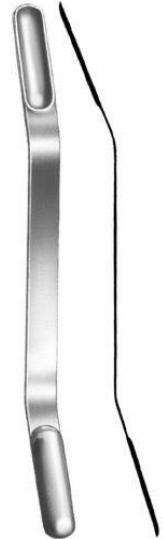

Olivecrona
BS-8-115-18
 Brain Spatula
 18 cm



Scoville
BS-8-116-23
 Nerve Root Retractor 8mm
 23.5 cm



Holsher
BS-8-117-24
 Nerve Root Retractor 8mm
 23.5 cm

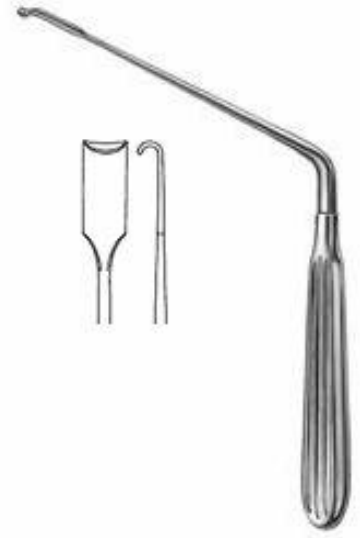

Scoville
BS-8-118-19
 Nerve Root Retractor 7mm
 16.5 cm



Groningen

BS-8-119-26

Nerve Hook
26.5 cm



Groningen

BS-8-120-26

Nerve Hook
26.5 cm



Cushing

BS-8-121-19

Nerve Hook blunt
19 cm , 28 cm

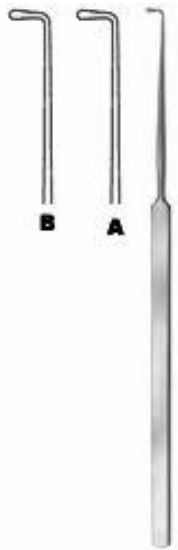

Cushing

BS-8-122-19

Nerve Hook
19.5 cm , 28 cm



Smithwick

BS-8-123-17

Smithwick
17 cm , 21 cm



Halle

BS-8-125-20

Dura Knife
20 cm



Adson

BS-8-126-20

Dura Hook
20 cm



Graham

BS-8-127-16

Dura Hook blunt
16.5 cm



Sachs

BS-8-128-18

Dura Hook sharp
18 cm



Toennis

BS-8-129-15

Dura Hook sharp
14.5 cm



Frazier

BS-8-130-13

Dura Hook sharp
13 cm , 18 cm



Krayenbuhl

BS-8-131-01

Nerve and Vessel Hooklet
18.5 cm Fig. 1 , 18.5 cm Fig. 2



Cloward

BS-8-132-16

Lamina Spreader
16 cm

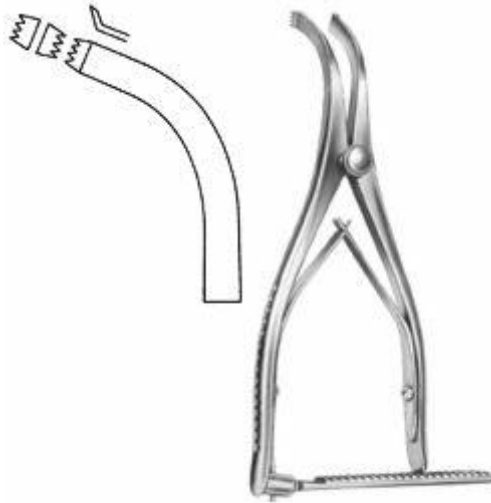

Inge

BS-8-133-17

Lamina Spreader
16 cm

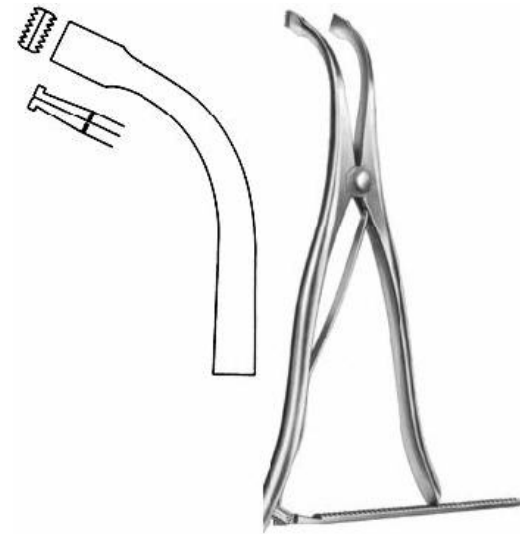

Inge

BS-8-134-27

Lamina Spreader
25.5 cm

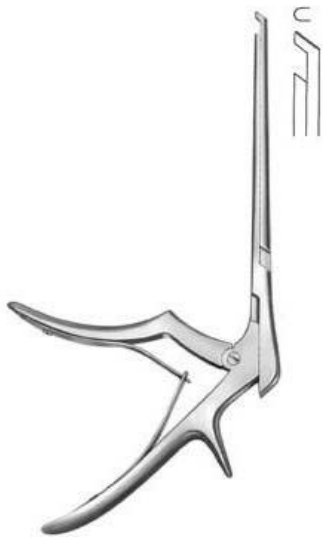

Ferris-Smith Kerrison

BS-8-135-03

Laminectomy Punch 3mm downwards cutting 40 degree shaft length 180 mm

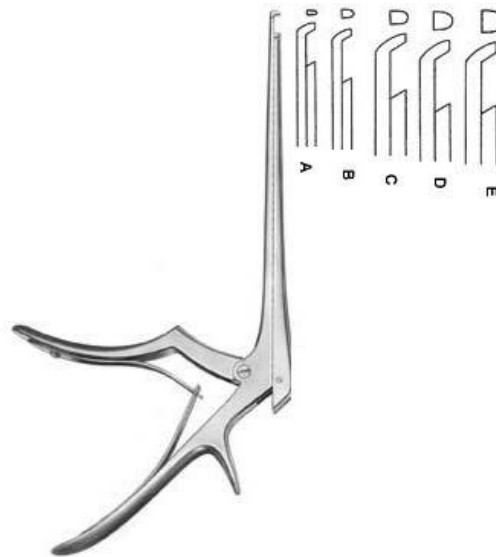

Ferris-Smith Kerrison

BS-8-138-01

Laminectomy Punch upwards cutting shaft length 180 mm
1 mm, 2 mm, 3 mm, 4 mm, 5 mm, 6 mm

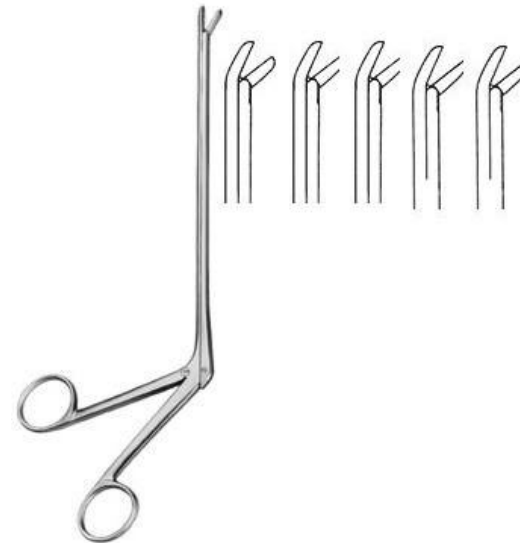

Cushing

BS-8-139-01

Laminectomy Rongeur jaw 2 x 10 to 4 x 10 mm straight shaft length 180 mm

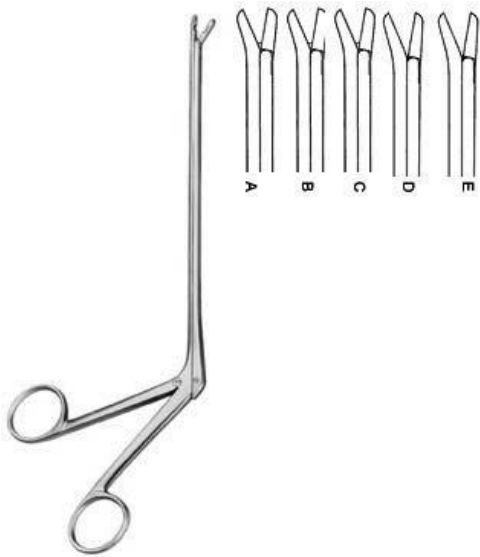

Cushing

BS-8-140-01

Laminectomy Rongeur jaw 2 x 10 to 4 x 10 mm upwards 45 degree shaft
length 120 mm



Ferris-Smith Kerrison

BS-8-137-01

Laminectomy Punch
1 mm, 2 mm, 3 mm, 4 mm, 5 mm, 6 mm



Bone Shear

BS-9-101-23

Bone Shear
23 cm



Rib Shear

BS-9-102-22

Rib Shear
23 cm



Gluck

BS-9-103-22

Rib Shears
21 cm



Giertz-Stille

BS-9-104-27

Rib Shear
24.5 cm



Lebsche

BS-9-105-24

Sternum Chisel
24.5 cm



Rib Retractor

BS-9-106-01

Rib Retractor lateral blades 12 x 16 mm spreading 95
mm

Size 1



Finochietto, Infant

BS-9-107-01



Finochietto, Baby

BS-9-108-01



Finochietto

BS-9-109-01

Rib Retractor lateral blades 15 x 15 mm spreading 75 mm Rib Retractor lateral blades 31 x 31 mm spreading 100 mm Rib Retractor lateral blades 40 x 45 mm spreading 135 mm

mm
Size 1

mm
Size 1

mm
Size 1



Burford

BS-9-110-01



Castaneda

BS-9-111-01



Finochietto (Modif.)

BS-9-112-01

Rib Retractor with two pairs of blades 47 x 62 mm + 65 mm Rib Retractor lateral blades 10,5 x 32 mm spreading 65 mm Rib Retractor lateral blades 14 x 15 mm spreading 120 mm

x 62 mm, spreading 200 mm
Size 1

mm
Size 1

mm
Size 1



Haight

BS-9-113-90

Rib Retractor lateral blades 30 x 30 mm spreading 120 mm
Size 1



Morse-Favaloro

BS-9-114-01

Sternal Retractor 4 movable blades 17 x 22 mm spreading 160 mm Sternal Retractor
Size 1



Morse

BS-9-115-00

Sternal Retractor 4 movable blades 22 x 27 mm spreading 200 mm
Size 1



Tuffier

BS-9-116-02

Rib Retractor lateral blades 22 x 27 mm spreading 200 mm
Size 1

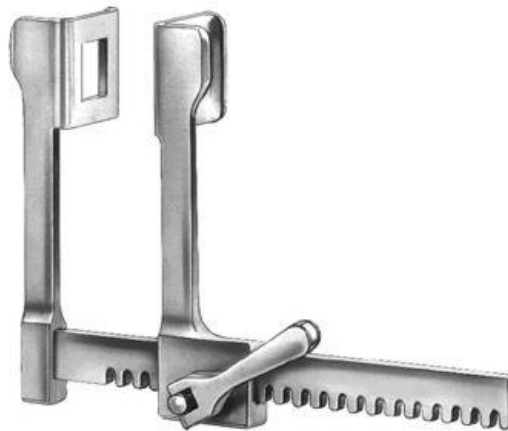

Finochietto, Baby

BS-9-117-75

Rib Retractor lateral blades 14 x 15 mm spreading 75 mm
Size 1



Finochietto

BS-9-118-01

Rib Retractor lateral blades 30 x 45 mm spreading 150 mm
Size 1



DeBakey

BS-9-119-00

Rib Retractor spreading 150 mm
Size 1



DeBakey

BS-9-120-00

Rib Retractor spreading 200 mm
Size 1



Thoracic Retractor

BS-9-121-00

Thoracic Retractor
Size 1



Sellors

BS-9-121-00

Rib Contractor
20 cm



Bailey-Baby

BS-9-123-14

Rib Contractor
15.5 cm



Bailey

BS-9-124-16

Rib Contractor
20 cm



Bailey-Gibbon

BS-9-125-16

Rib Contractor
20 cm



Allison

BS-9-126-30

Lung Spatula
29.5 cm, 32.5 cm



Price-Thomas

BS-9-127-22

Bronchus Clamp
22 cm

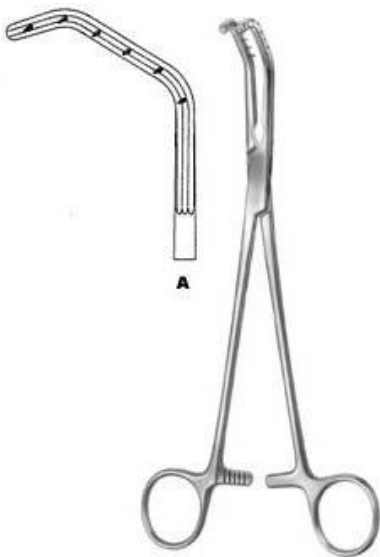

Price-Thomas

BS-9-128-22

Bronchus Clamp
22 cm

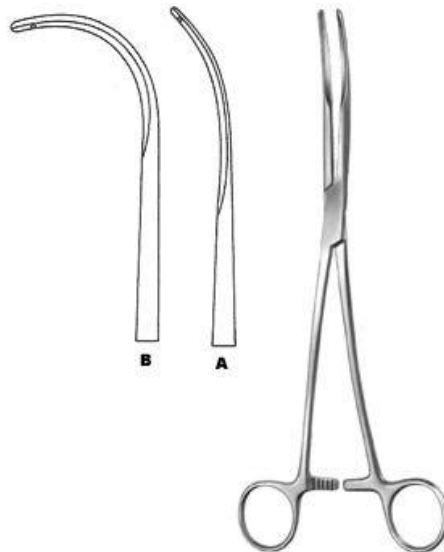

Semb

BS-9-129-24

Bronchus Clamp
24.5 cm

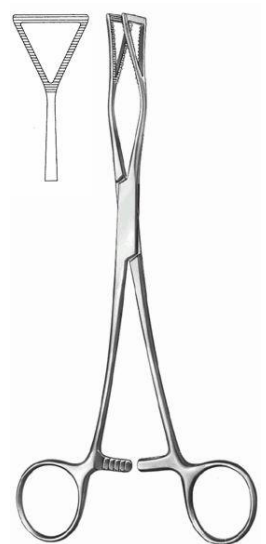

Lovlace

BS-9-130-20

Lung Grasping Forceps
20.5 cm

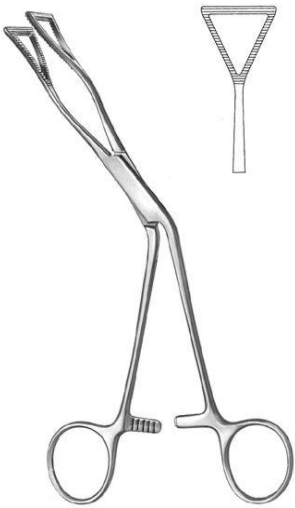

Lovelace

BS-9-131-20

Lung Grasping Forceps
19 cm



DeBakey-Satinsky

BS-9-132-07

Bulldog Clamp
7", 9 cm



Glover

BS-9-133-06

Bulldog Clamp
6 cm



Santulli

BS-9-134-07

Bulldog Clamp
7



Gregory, Soft

BS-9-135-09

Bulldog Clamp
9 cm, 11 cm



Gregory

BS-9-136-01

Bulldog Clamp
10.5 cm

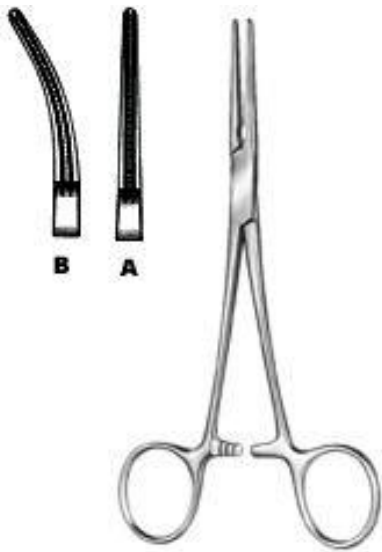

DeBakey-Rankin

BS-9-137-16

Haemostatic Forceps
16 cm



DeBakey-Mosquito

BS-9-138-15

Haemostatic Forceps
15 cm



Ochsner

BS-9-139-23

Aortic Clamp
23.5 cm



Diethrich

BS-9-140-21

Aortic Clamp
22 cm

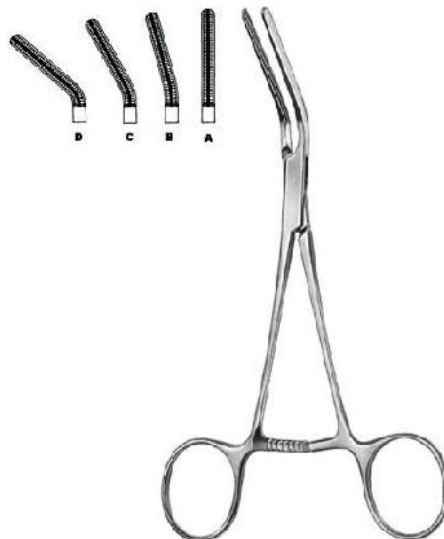

Dardik

BS-9-141-00

Multi purpose Vascular Clamp
15 cm



Dale

BS-9-142-18

Peripheral Vascular Clamp
18 cm

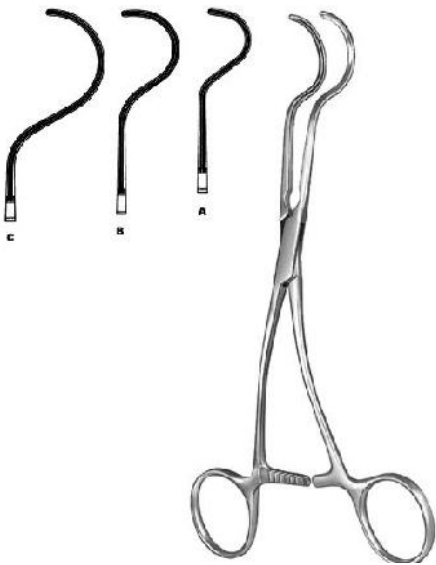

Dale

BS-9-143-17

Peripheral Vascular Clamp
17.5 cm

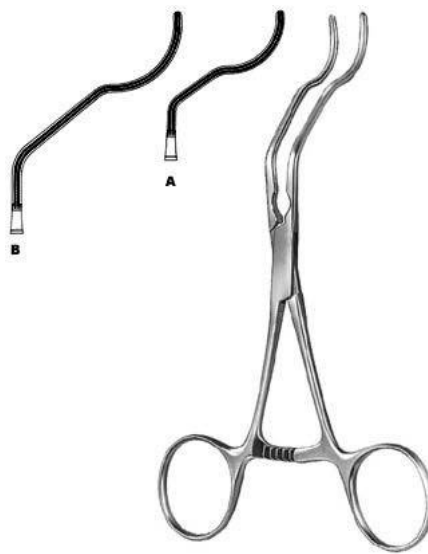

Gregory

BS-9-144-14

Profunda Clamp
13 cm , 16 cm, 18 cm

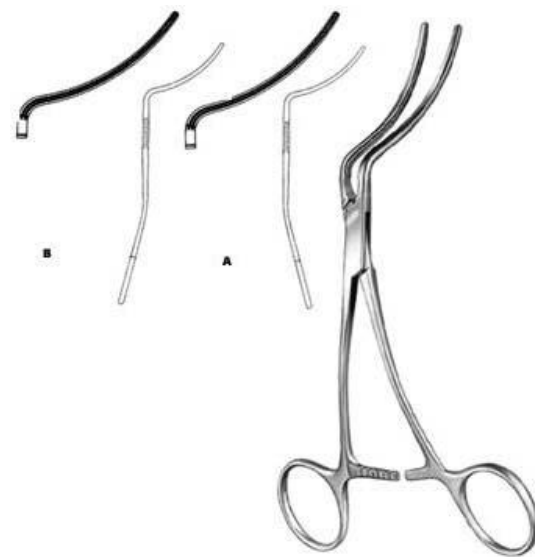

Martin

BS-9-145-16

Peripheral Vascular Clamp
16.5 cm



Husfeldt

BS-9-146-18

Peripheral Vascular Clamp
17.5 cm



Husfeldt

BS-9-147-18

Peripheral Vascular Clamp
18 cm

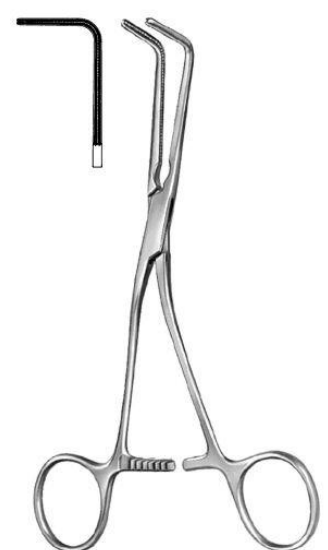

Husfeldt

BS-9-148-17

Peripheral Vascular Clamp
17 cm

Cardiovascular

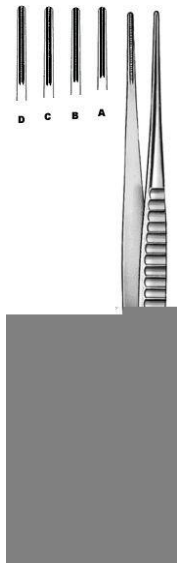

DeBakey

BS-9-149-16

Vascular Forceps
16 cm



DeBakey

BS-9-150-16

Vascular Forceps
16 cm



DeBakey

BS-9-151-16

Vascular Forceps
16 cm

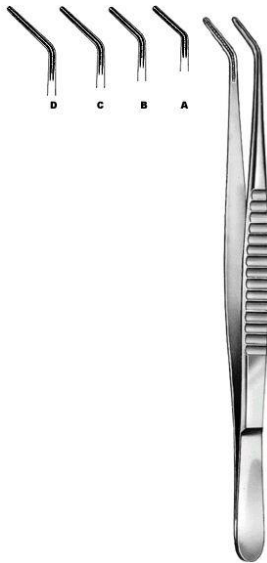

DeBakey

BS-9-152-16

Vascular Forceps
16 cm



DeBakey

BS-9-153-16

Vascular Forceps
16 cm



DeBakey

BS-9-154-07

Bulldog Clamp
7



DeBakey

BS-9-155-07

Bulldog Clamp
7



Applying Forceps

BS-9-156-23

Applying Forceps
23.5 cm

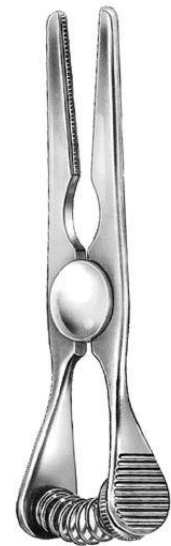

Glover

BS-9-157-06

Bulldog Clamp
7



Glover

BS-9-158-06

Bulldog Clamp
6.5 cm

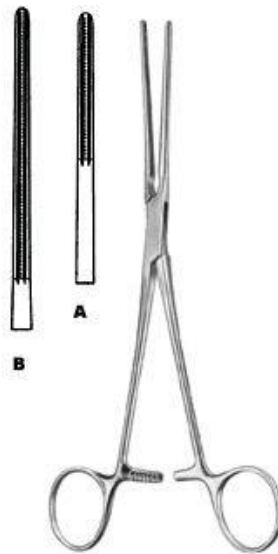

Potts

BS-9-159-21

Coarctation Clamp
21 cm

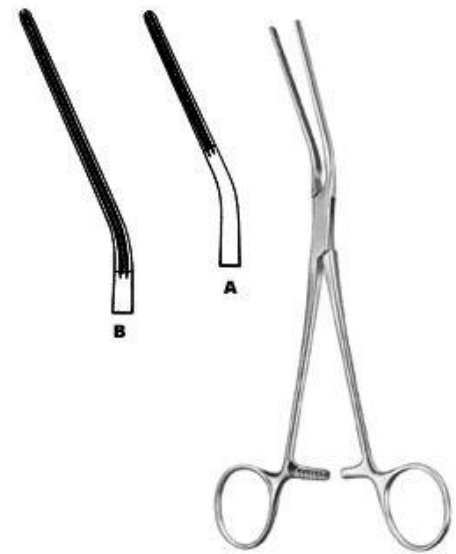

Potts

BS-9-160-21

Coarctation Clamp
20.5 cm

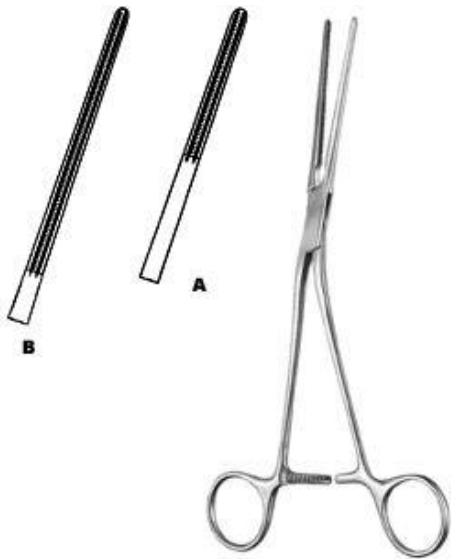

Potts
BS-9-161-21
Coarctation Clamp
20.5 cm



Potts
BS-9-162-22
Anastomosis Clamp
21.5 cm



Potts
BS-9-163-22
Anastomosis Clamp
22 cm

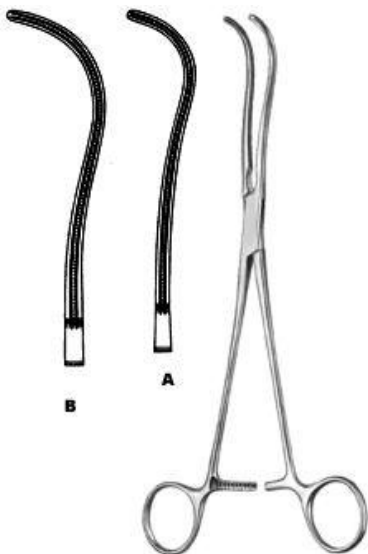

DeBakey
BS-9-164-19
Ligature Forceps
19 cm



DeBakey
BS-9-165-16
Peripheral Vascular Clamp
16 cm



DeBakey
BS-9-166-19
Peripheral Vascular Clamp
16 cm

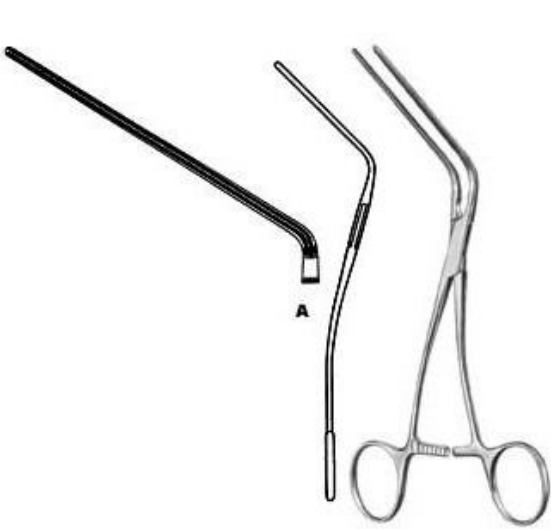

Leland-Jones

BS-9-167-18

Peripheral Vascular Clamp
18 cm



Bainbridge

BS-9-168-15

Multi purpose Vascular Clamp
15 cm



Bainbridge

BS-9-169-15

Multi purpose Vascular Clamp
15 cm

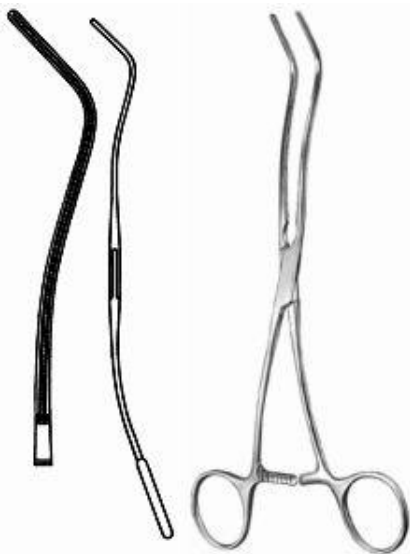

DeBakey

BS-9-170-20

Multi purpose Vascular Clamp
20 cm



DeBakey

BS-9-171-26

Aortic Aneurysm Clamp
26 cm



DeBakey

BS-9-172-28

Aortic Aneurysm Clamp
28 cm



DeBakey

BS-9-173-30

Aortic Aneurysm Clamp
30 cm



DeBakey

BS-9-174-27

Aortic Clamp
27 cm



DeBakey

BS-9-175-24

Ligature Forceps
24.5 cm



DeBakey

BS-9-176-24

Ligature Forceps
24.5 cm



DeBakey

BS-9-178-25

Ligature Forceps
27 cm

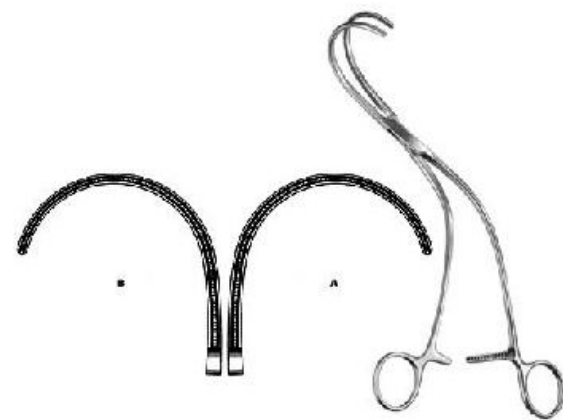

Weber

BS-9-179-01

Aortic Clamp
24 cm



Satinsky

BS-9-180-20

Tangential Occlusion Clamp
22 cm



Harken

BS-9-181-01

Auricle Clamp
24.5 cm



Lees

BS-9-182-23

Bronchus Clamp
23 cm



Lees

BS-9-183-25

Bronchus Clamp
25 cm



Lambert-Kay

BS-9-184-21

Anastomosis Clamp
22.5 cm



DeBakey

BS-9-185-17

Anastomosis Clamp
16.5 cm



Morris-DeBakey

BS-9-186-18

Aortic Clamp

16.5 cm



DeBakey-Bahnson

BS-9-187-23

Aneurysm Clamp

23.5 cm

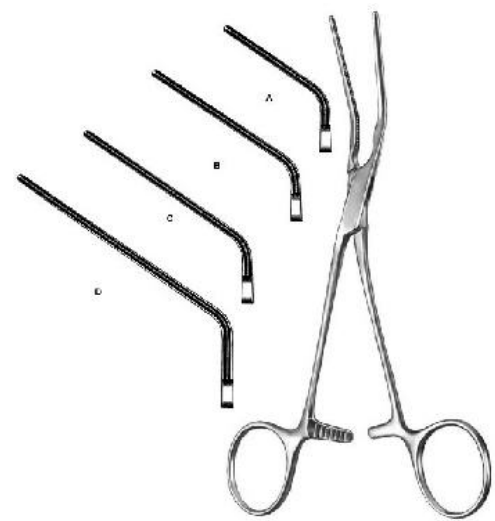

DeBakey

BS-9-188-20

Multi purpose Vascular Clamp

18 cm

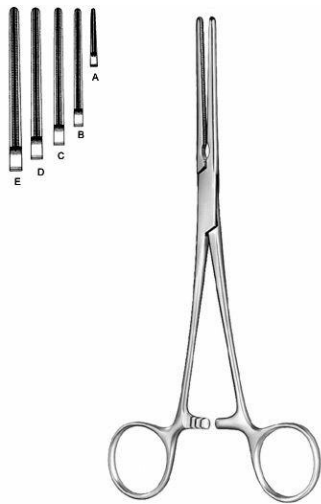

DeBakey-Mosquito

BS-9-189-12

Haemostatic Forceps

12.5 cm



DeBakey-Mosquito

BS-9-190-12

Haemostatic Forceps

12.5 cm



DeBakey

BS-9-191-17

Multi purpose Vascular Clamp

17 cm



DeBakey

BS-9-192-16

Multi purpose Vascular Clamp
16.5 cm

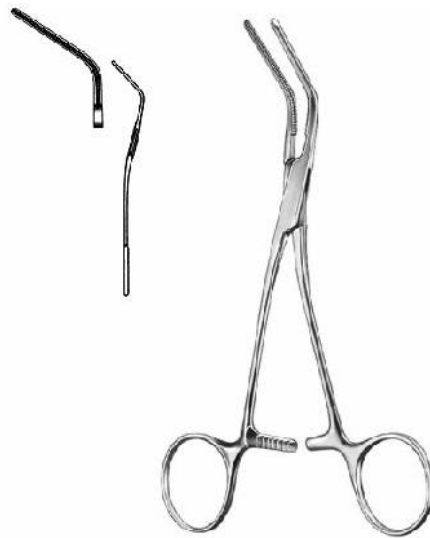

DeBakey

BS-9-193-15

Multi purpose Vascular Clamp
16 cm

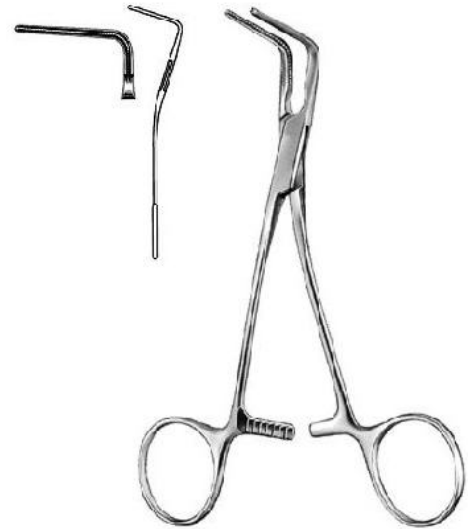

DeBakey

BS-9-194-15

Multi purpose Vascular Clamp
16.5 cm



DeBakey

BS-9-195-17

Multi purpose Vascular Clamp
16.5 cm



Glover

BS-9-196-17

Multi purpose Vascular Clamp
17 cm



Glover

BS-9-197-17

Multi purpose Vascular Clamp
17.5 cm

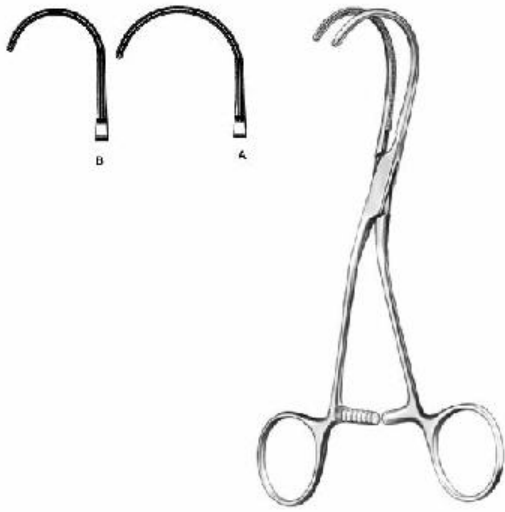

DeBakey

BS-9-198-16

Multi purpose Vascular Clamp
16.5 cm

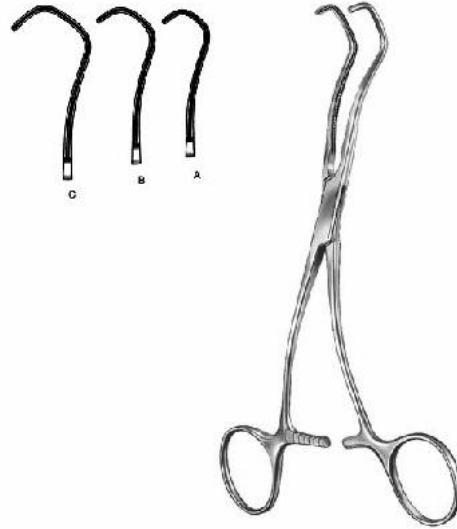

Derra

BS-9-199-16

Anastomosis Clamp
16 cm Fig. 1, 17.5 cm Fig. 3, 18.5 cm Fig. 3



DeBakey-Beck

BS-9-200-17

Anastomosis Clamp
17 cm



Cooley

BS-9-201-16

Vascular Forceps
16 cm

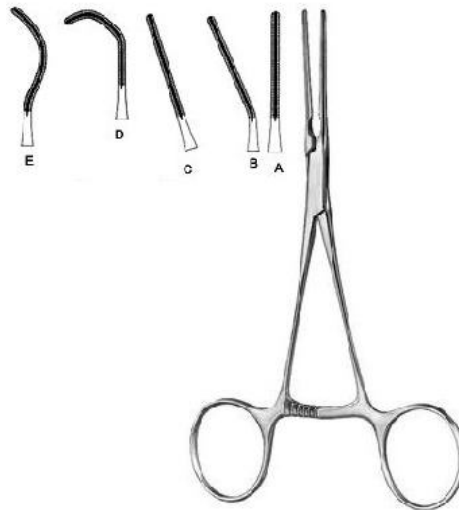

Cooley

BS-9-202-01

Pediatric Vascular Clamp
14.5 cm



Cooley

BS-9-203-21

Iliac Clamp
22 cm



Cooley
BS-9-204-17
Anastomosis Clamp
17 cm

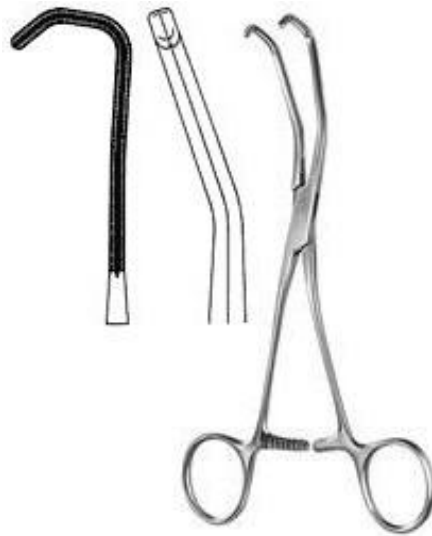

Cooley
BS-9-205-17
Anastomosis Clamp
20 cm



Cooley
BS-9-206-16
Anastomosis Clamp
17 cm



Cooley
BS-9-207-15
Multi purpose Vascular Clamp
16 cm



Cooley
BS-9-208-17
Multi purpose Vascular Clamp
17 cm



Cooley
BS-9-209-17
Multi purpose Vascular Clamp
17 cm



Cooley

BS-9-210-17

Multi purpose Vascular Clamp
17.5 cm

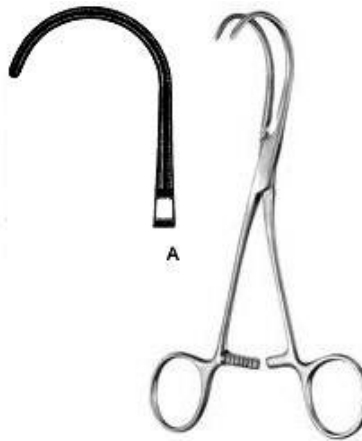

Cooley

BS-9-211-16

Multi purpose Vascular Clamp
16.5 cm



Cooley-Derra

BS-9-212-16

Anastomosis Clamp
16.5 cm



Cooley-Beck

BS-9-213-17

Anastomosis Clamp
17 cm

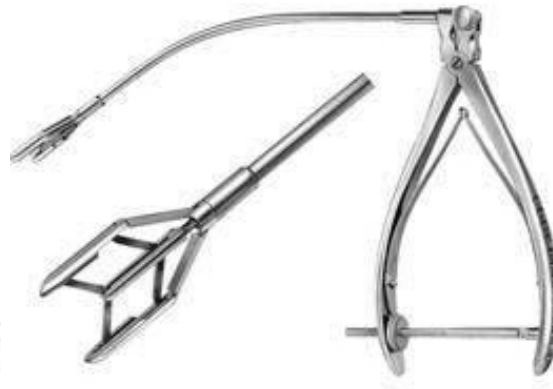

Cooley

BS-9-214-00

Aortic Dilator



Cooley

BS-9-215-05

Vascular Dilator
14 cm / 5 ? 11



DeBakey

BS-9-216-05

Vascular Dilator
19 cm



Martin

BS-9-217-00

Tunneling Set complete set with three shafts, two handles and 12 tips in storage case.



Hach

BS-9-218-01

Fasciotomy Knife with plastic handle
30 cm



Intima Spatula

BS-9-219-18

Intima Spatula
18.5 cm

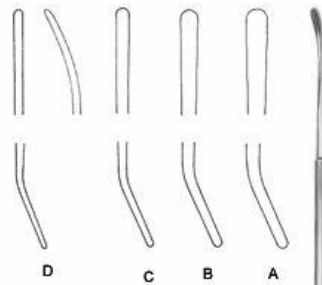

Robb

BS-9-220-01

Vascular Dissector
24 cm Fig. 1 2,5 mm ? , 24 cm Fig. 2 2,0 mm ?



Crile

BS-9-221-20

Nerve Hooklet
20 cm

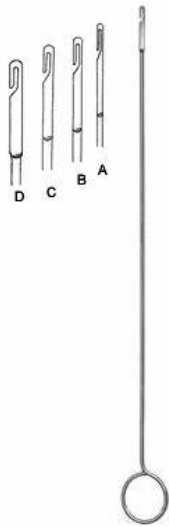

Ligature Catcher

BS-9-222-15

Ligature Catcher
26 cm 1,5 mm



Subramanian-Miniature

BS-9-223-15

Aortic Clamp 135 degree
15.5 cm

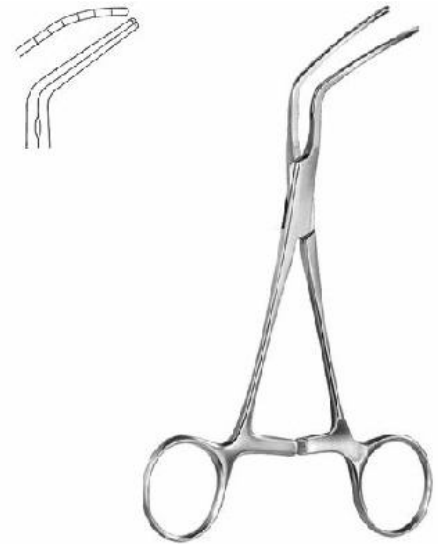

Subramanian

BS-9-224-16

Aortic Clamp
16 cm

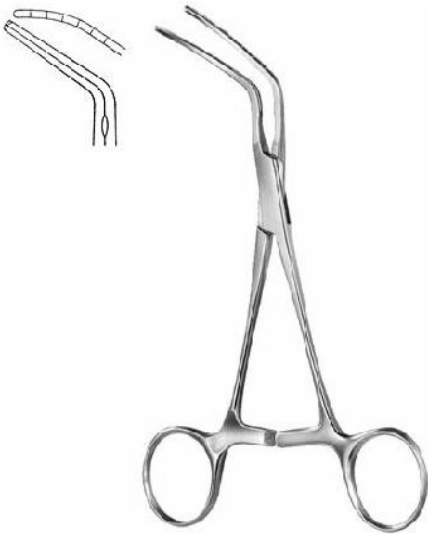

Subramanian

BS-9-225-16

Aortic Clamp
14 cm Fig. 1 , 14 cm Fig. 2 , 14 cm Fig. 3

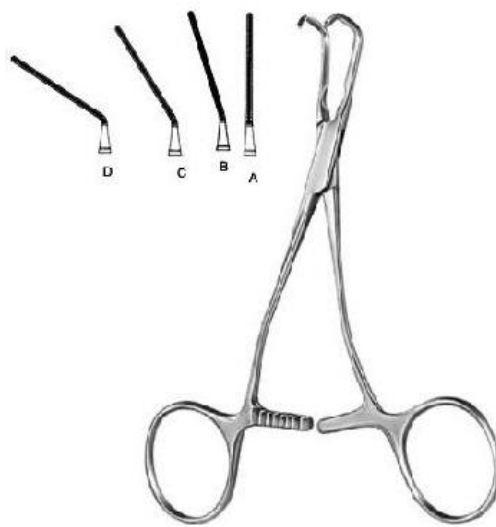

Pediatric Vascular Clamp

BS-9-226-01

Pediatric Vascular Clamp



Pediatric Vascular Clamp

BS-9-227-16

Pediatric Vascular Clamp
16.5 cm



Pediatric Vascular Clamp

BS-9-228-16

Pediatric Vascular Clamp
16 cm



Barraquer (Colibri)

BS-11-101-03

Barraquer
Size 1

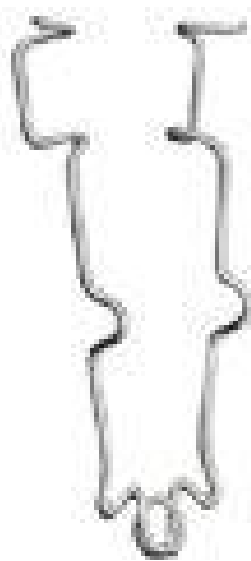

Bowman

BS-11-102-07

Bowman
Size 1



Critchett

BS-11-103-06

Critchett
Size 1

Tracheotomy

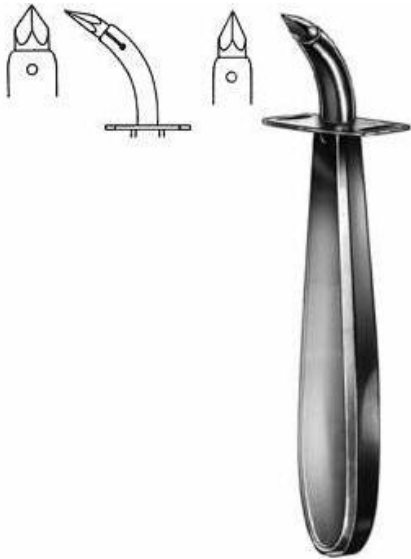

Ueckermann

BS-16-101-13

Tracheotomy Trocar
11.5 cm



Iterson

BS-16-102-16

Tracheal Hook
17 cm

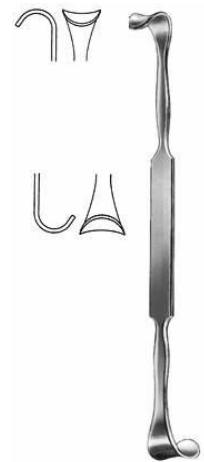

Rose

BS-16-103-13

Tracheal Hook
13.5 cm



Luer

BS-16-104-11

Tracheal Hook
11 cm

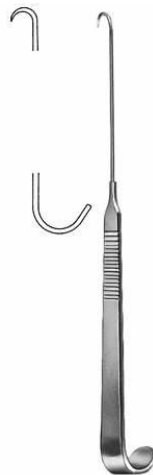

Tracheal Hook

BS-16-105-15

Tracheal Hook
15 cm

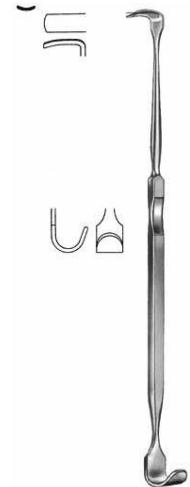

Lukens

BS-16-106-17

Thymus Retractor
17.5 cm

Tracheotomy



Jackson

BS-16-107-17

Tracheal Hook
18 cm



Kocher

BS-16-108-15

Goitre Enucleator
16.5 cm



Kocher

BS-16-109-15

Goitre Enucleator
16.5 cm



Hofmeister

BS-16-110-21

Goitre Enucleator
20.5 cm



Lahey

BS-16-111-15

Goitre Grasping Forceps
15.5 cm



Luer

BS-16-112-04

Tracheal Tube



Luer

BS-6-113-08

Tracheal Tube



Chevalier-Jackson

BS-16-114-04

Tracheal Tube outer tube closed inner tube
closed silver



Speaking Tube

BS-16-115-08

Speaking Tube



Moncorps

BS-17-101-14

Milium Knife
14 cm



Moncorps

BS-17-102-00

Spare Blade



Vidal

BS-17-103-14

Lupus Scraper
13 cm



Wolff

BS-17-105-01

Lupus Curette
14 cm



Kilner

BS-17-106-15

Skin Hooklet
14.5 cm



Gillies

BS-17-107-18

Skin Hooklet
18 cm



Kaye

BS-17-108-03

Face-lift Hook
13 cm

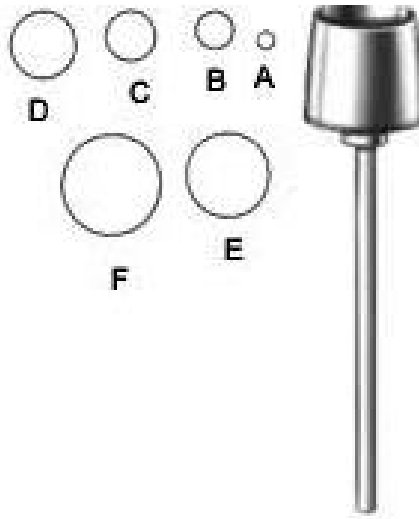

Dermal Punch

BS-17-109-02

Dermal Punch
5.5 cm



Handle

BS-17-110-00

Handle
8 cm

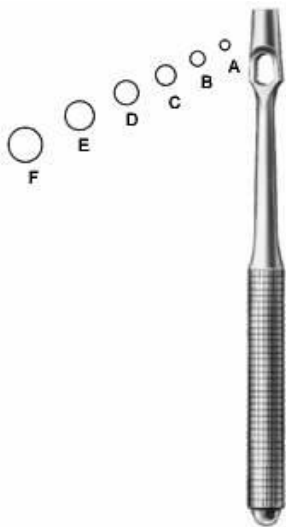

Keyes

BS-17-111-02

Dermal Punch
11 cm



Unna

BS-17-113-14

Comedone Extractor
14.5 cm



Saalfeld

BS-17-114-10

Comedone Extractor
11 cm



Saalfeld

BS-17-115-14

Saalfeld Comedone Extractor
14.5 cm



Schamberg

BS-17-116-10

Comedone Extractor
9.5 cm



Katsch

BS-17-117-14

Comedone Extractor
16 cm



Unna-Vidal

BS-17-118-11

Comedone Extractor
11.5 cm



D'Assump?

BS-17-119-15

Face-lift Forceps
18 cm



Gregory

BS-17-120-14

Face-lift Scissors
14 cm

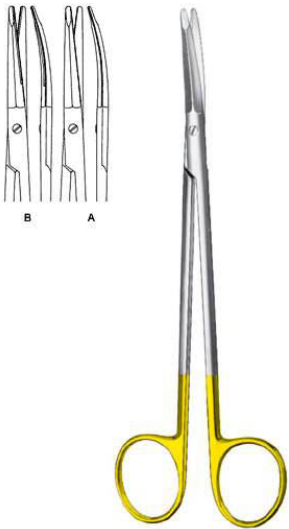

Kaye

BS-17-121-15

Face-lift Scissors
15 cm, 18 cm

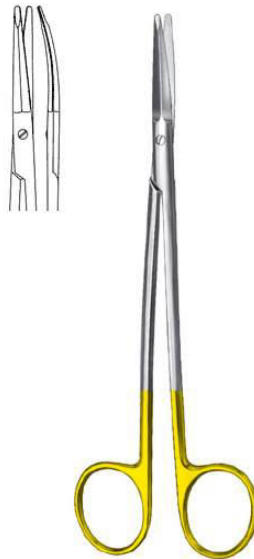

Stella-S

BS-17-122-18

Face-lift Scissors
18 cm

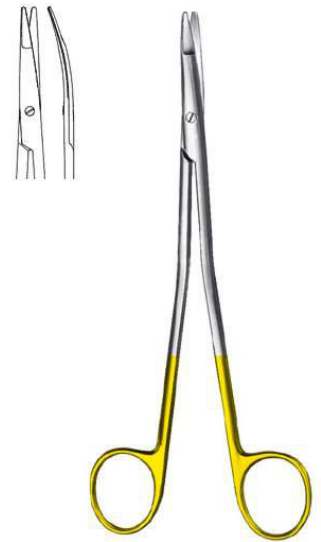

Gorney

BS-17-123-18

Face-lift Scissors
18 cm

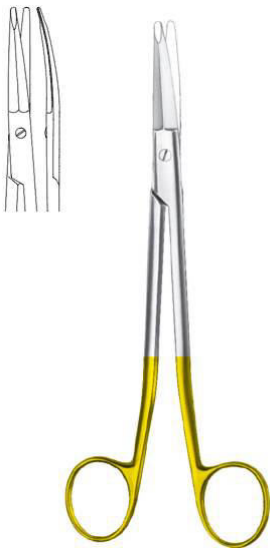

Freeman-Kaye

BS-17-124-18

Face-lift Scissors
18 cm

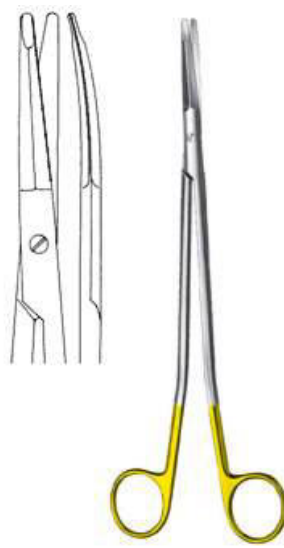

Freeman

BS-17-125-00

Face-lift Scissors
23 cm



Fox

BS-17-104-01

Lupus Curette
14 cm



Unna

BS-17-112-14

Comedone Extractor

14.5 cm

Intestines & Stomach



Allis-Baby

BS-18-101-12

Intestinal and Tissue Grasping Forceps
13 cm

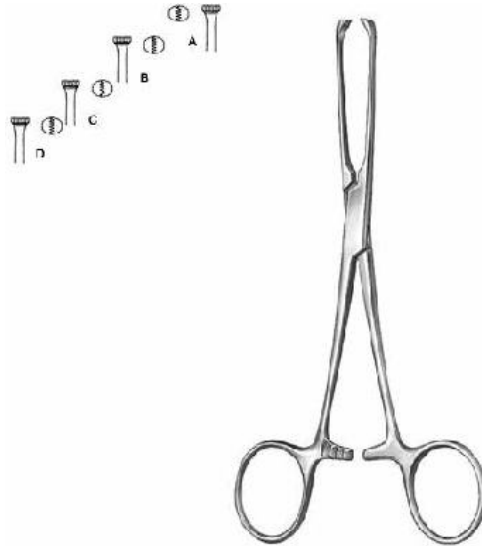

Allis

BS-18-102-15

Intestinal and Tissue Grasping Forceps
15.5 cm, 19 cm , 25.5 cm

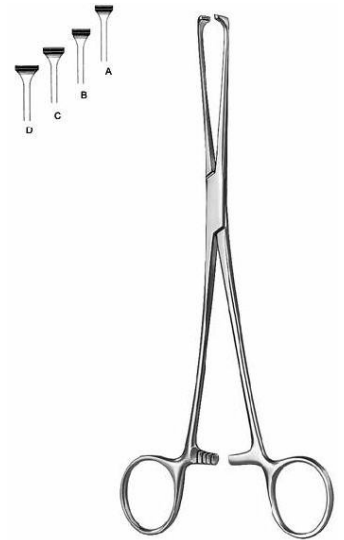

Allis

BS-18-103-16

Intestinal and Tissue Grasping Forceps
15.5 cm, 20 cm, 24.5 cm, 30 cm



Allis-Adair

BS-18-104-15

Intestinal and Tissue Grasping Forceps
16 cm



Boys-Allis

BS-18-105-15

Intestinal and Tissue Grasping Forceps
15.5 cm



Thoms-Allis

BS-18-106-20

Intestinal and Tissue Grasping Forceps
20.5 cm

Intestines & Stomach



Allis

BS-18-107-20

Intestinal and Tissue Grasping Forceps
20 cm

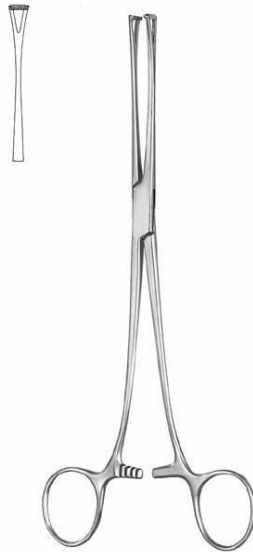

Lockwood

BS-18-108-20

Intestinal and Tissue Grasping Forceps
20 cm



Williams

BS-18-109-16

Intestinal and Tissue Grasping Forceps
16.5 cm

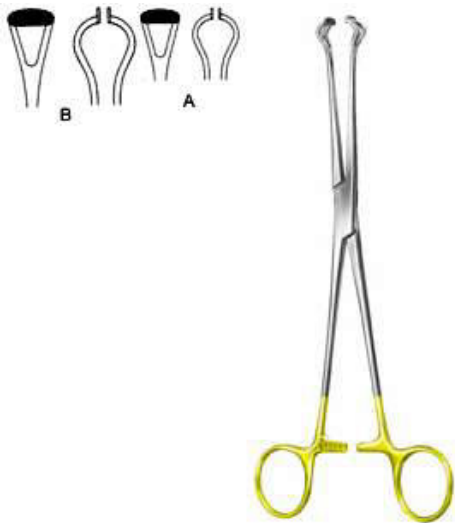

Babcock

BS-18-110-16

Intestinal and Tissue Grasping Forceps
16.5 cm, 21 cm

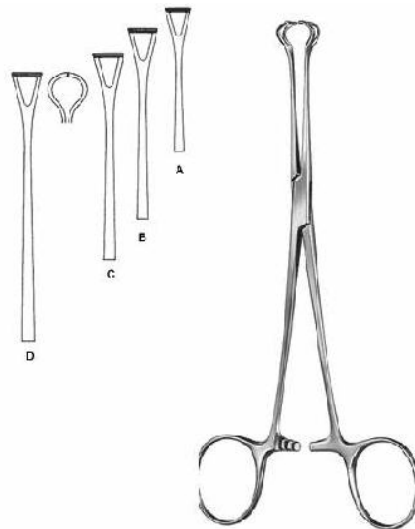

Babcock

BS-18-111-16

Intestinal and Tissue Grasping Forceps
15.5 cm, 17.5 cm, 21 cm, 24 cm

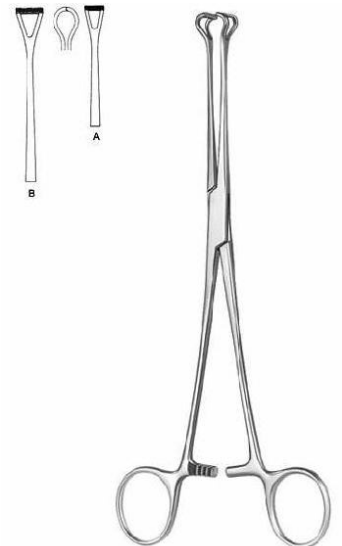

Babcock

BS-18-112-16

Intestinal and Tissue Grasping Forceps
16.5 cm, 25.5 cm

Intestines & Stomach



Duval

BS-18-113-20

Intestinal and Tissue Grasping Forceps
20.5 cm

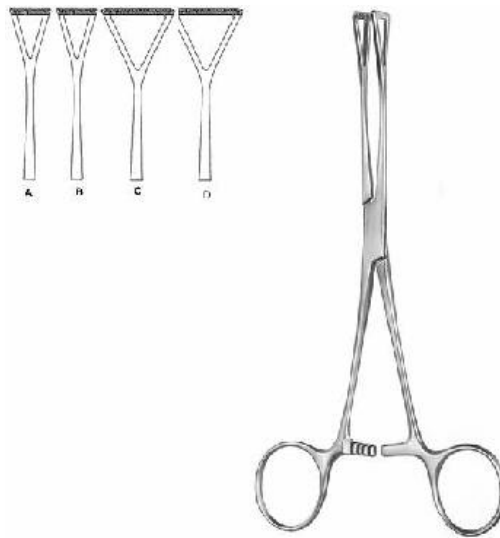

Duval

BS-18-114-18

Intestinal and Tissue Grasping Forceps
18 cm, 25.5 cm, 23 cm

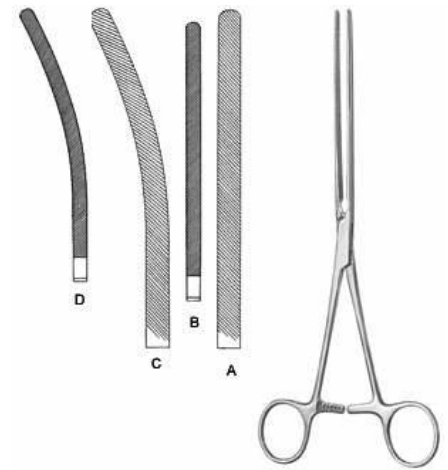

Doyen

BS-18-115-21

Intestinal Clamp
21.5 cm, 23.5 cm



Doyen-Baby

BS-18-116-18

Intestinal Clamp
18 cm, 17.5 cm



Mayo-Robson

BS-18-117-21

Intestinal Clamp
21.5 cm, 23.5 cm, 23 cm

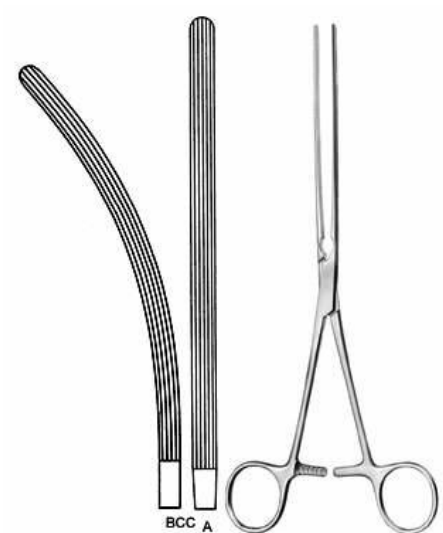

Mayo-Robson

BS-18-118-25

Intestinal Clamp
25.5 cm, 24.5 cm



Intestines & Stomach

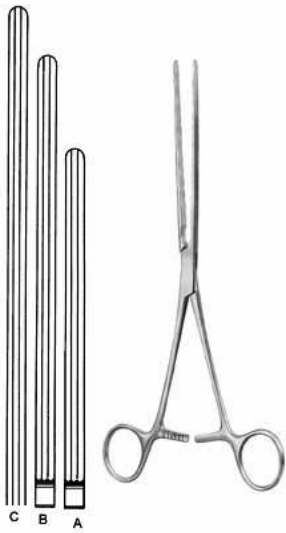

Kocher

BS-18-119-22

Intestinal Clamp
22.5 cm, 25 cm, 28.5 cm

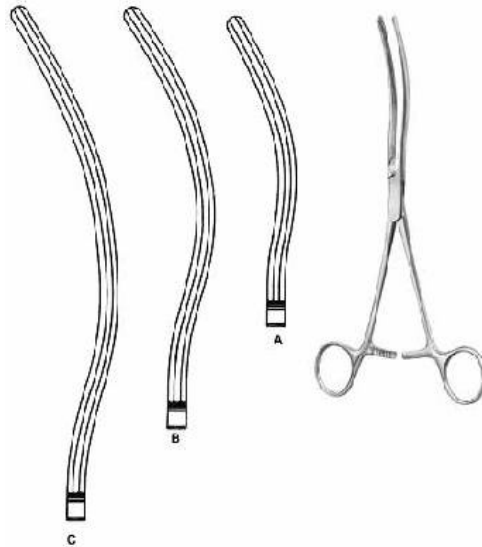

Kocher

BS-18-120-22

Intestinal Clamp
22 cm, 24.5 cm, 27.5 cm



Allen

BS-18-121-16

Intestinal Clamp
16 cm



Payr-Baby

BS-18-122-15

Intestinal and Pylorus Clamp
15 cm

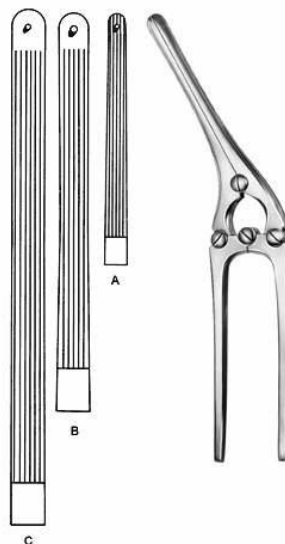

Payr

BS-18-123-21

Intestinal and Pylorus Clamp
20.5 cm, 29 cm, 34.5 cm



Stone-Watt

BS-18-124-07

Intestinal Anastomosis Clamp
8.5 cm, 10 cm



Intestines & Stomach



Stone-Watt

BS-18-125-15

Closing Forceps

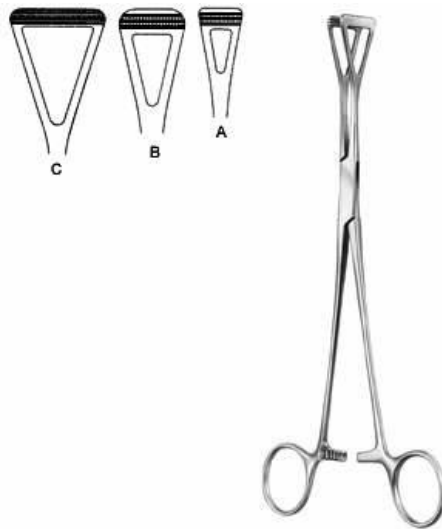

Scheibe

BS-18-126-18

Organ Grasping Forceps
18 cm

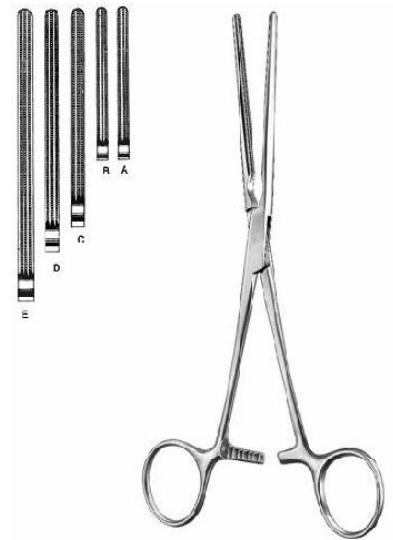

Doyen-Baby

BS-18-127-13

Intestinal Clamp
14 cm, 17 cm

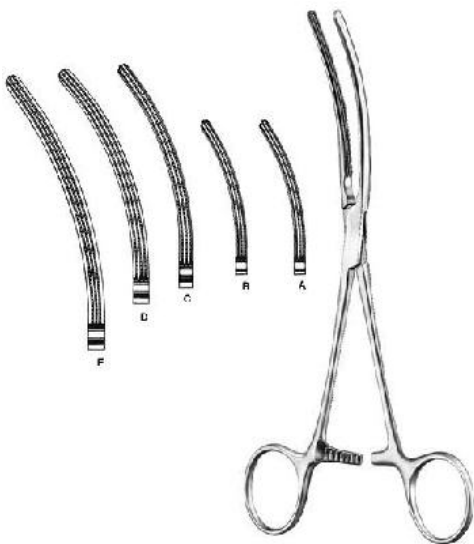

Doyen-Baby

BS-18-128-13

Intestinal Clamp
13.5 cm, 17 cm



Mayo-Robson

BS-18-129-25

Intestinal Clamp
26 cm



Mayo-Robson

BS-18-130-25

Intestinal Clamp
25 cm

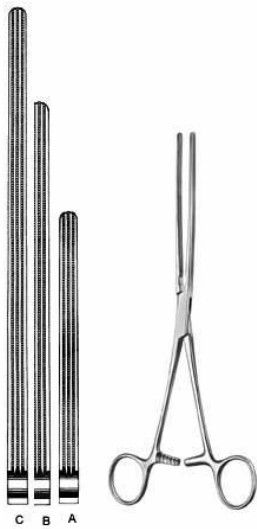

Kocher

BS-18-131-22

Intestinal Clamp
22.5 cm, 28 cm

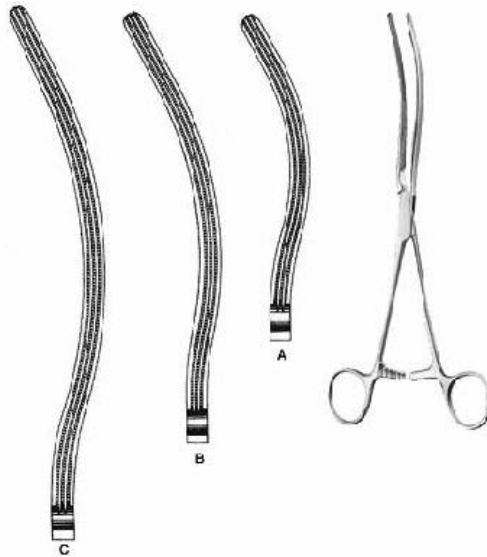

Kocher

BS-18-132-22

Intestinal Clamp
22 cm, 25 cm, 27.5 cm

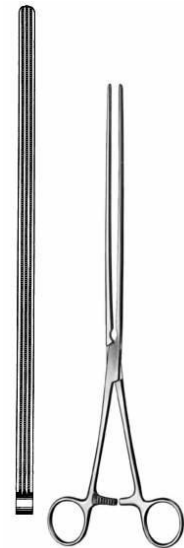

Scudder

BS-18-133-33

Intestinal Clamp
33.5 cm

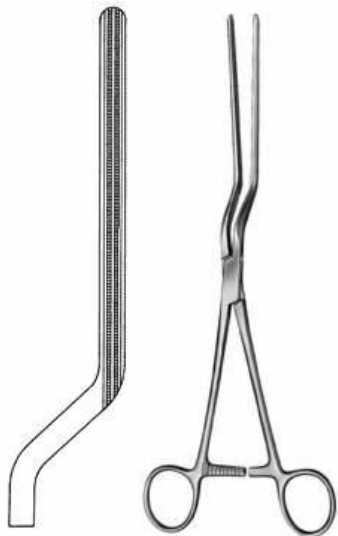

Brunner

BS-18-134-24

Sigmoid Anastomosis Forceps
27 cm

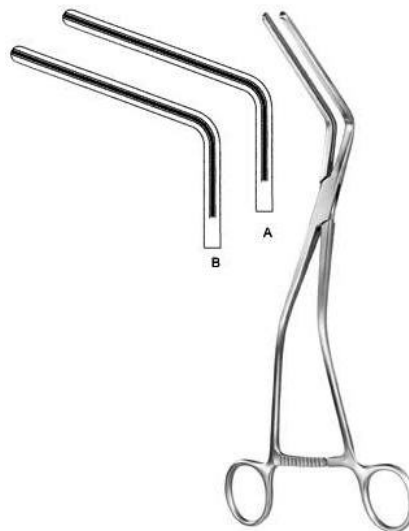

Hayes

BS-18-135-26

Sigmoid Anastomosis Forceps
27 cm, 28 cm



Veidenheimer

BS-18-136-23

Sigmoid Anastomosis Forceps
25 cm

Intestines & Stomach



Fehland

BS-18-137-24

Sigmoid Anastomosis Forceps
24 cm

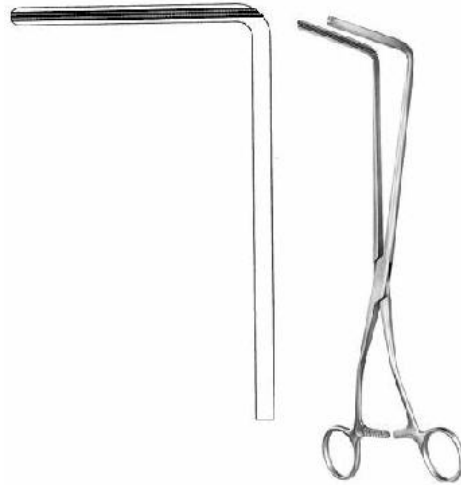

Resano

BS-18-138-30

Sigmoid Anastomosis Forceps
28 cm



Sims

BS-18-139-15

Rectal Speculum
15.5 cm



Sims

BS-18-140-15

Rectal Speculum
15.5 cm



Mathieu

BS-18-141-19

Rectal Speculum
19 cm



Alan-Parks

BS-18-142-00

Alan-Parks
14 cm

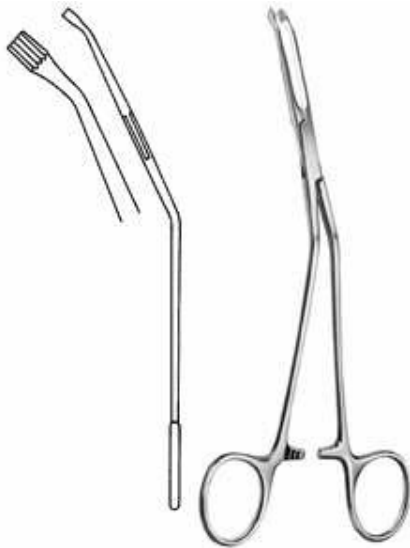

McGinvey

BS-18-143-19

Hemorrhoidal Grasping Forceps
19 cm



Handle For Biopsy Forceps

BS-18-144-00

Handle for biopsy forceps



Rectal Biopsy Forceps

BS-18-145-38

Rectal Biopsy Forceps

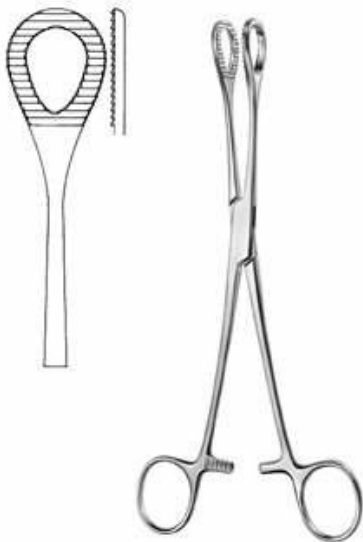

Heywood-Smith

BS-18-146-21

Polypus Grasping Forceps
21 cm

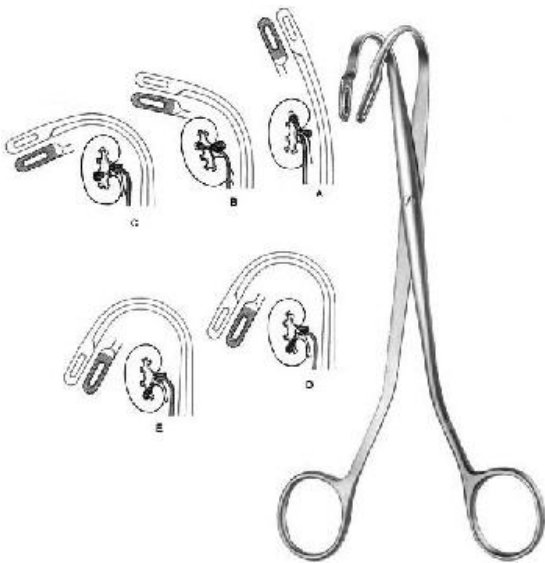

Randall

BS-19-101-23 A

Kidney Stone Forceps
23 cm Fig. 1 , 21 cm Fig. 2, 21 cm Fig. 3



Randall

BS-19-102-23 A

Kidney Stone Forceps
23 cm , 24.5 cm

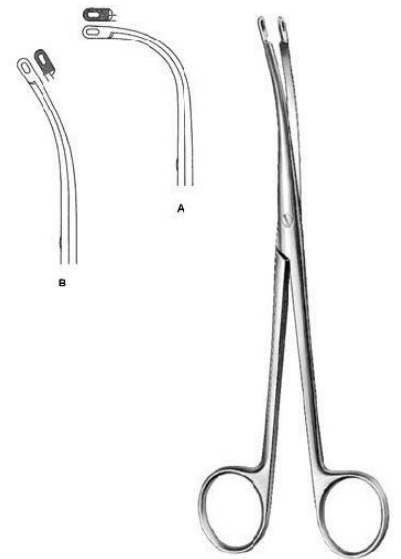

Heiming

BS-19-103-16 A

Kidney Stone Forceps
16 cm Fig. 1, 17 cm Fig. 2

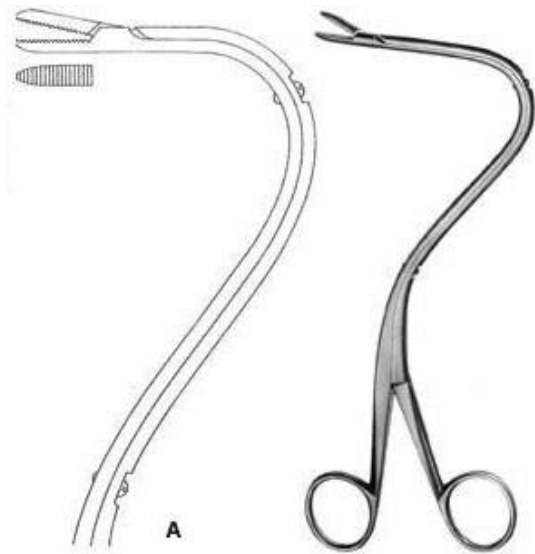

Elsasser

BS-19-104-01 A

Nephrostomy Forceps
21 cm Fig. 1 , 21 cm Fig. 2

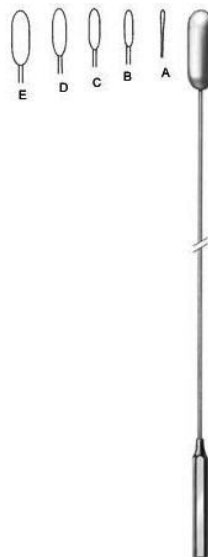

Bakes

BS-19-105-01 A

Gall Duct Dilator
32 cm

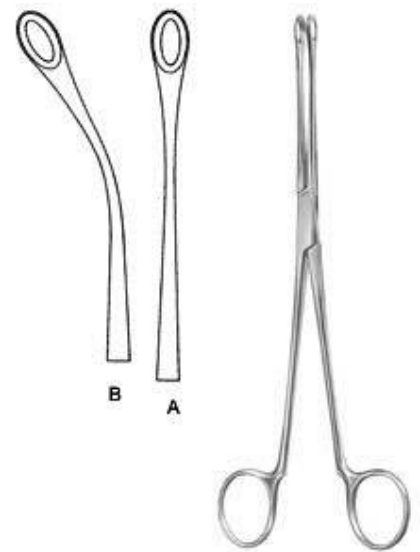

Blake

BS-19-106-20 A

Gall Stone Forceps
21 cm



Mayo-Blake

BS-19-107-20

Gall Stone Forceps
21 cm



Mayo-Blake

BS-19-108-20

Gall Stone Forceps
21 cm



Mixer

BS-19-109-22

Gall Stone Forceps
21.5 cm



Desjardins

BS-19-110-23 A

Gall Stone Forceps
23 cm

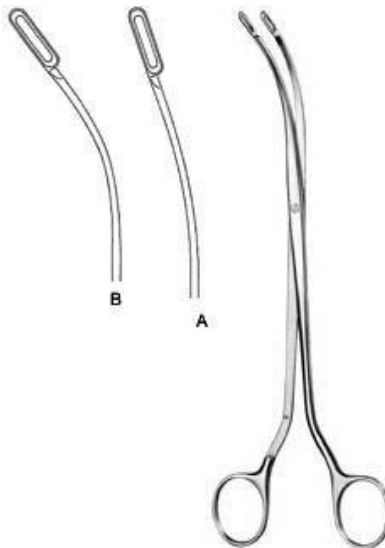

Desjardins

BS-19-111-24 A

Gall Stone Forceps



Luer-Korte

BS-19-112-01 A

Gall Stone Scoop
32 cm Fig. 0, 32 cm Fig. 00, 32 cm Fig. 000, 32 cm Fig. 1, 32 cm Fig. 2, 32 cm Fig. 3, 32 cm Fig. 4

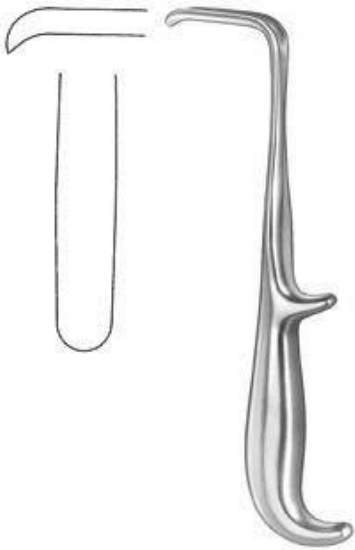

Young
BS-19-113-21
Prostatic Retractor
21.5 cm



Young
BS-19-114-22
Prostatic Retractor
20.5 cm

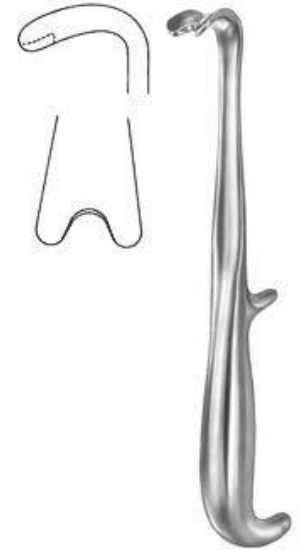

Young
BS-19-115-21
Prostatic Retractor
22 cm

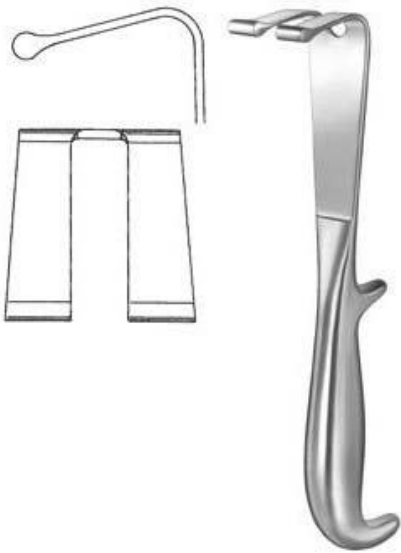

Young
BS-19-116-22
Prostatic Retractor
21.5 cm

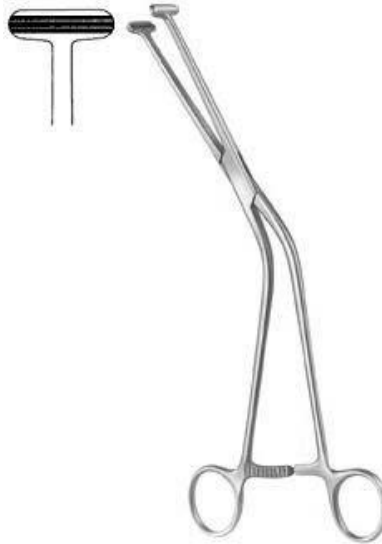

Millin
BS-19-117-24
Capsule Forceps
24.5 cm

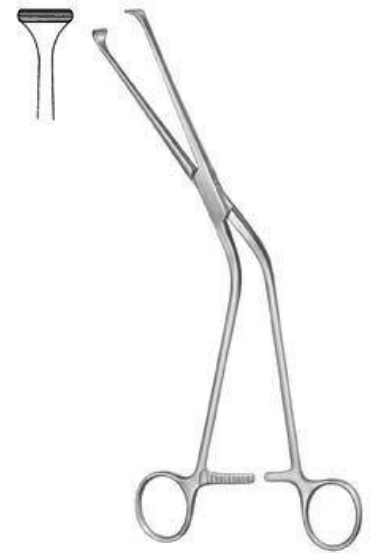

Millin
BS-19-118-24
Capsule Forceps
22 cm

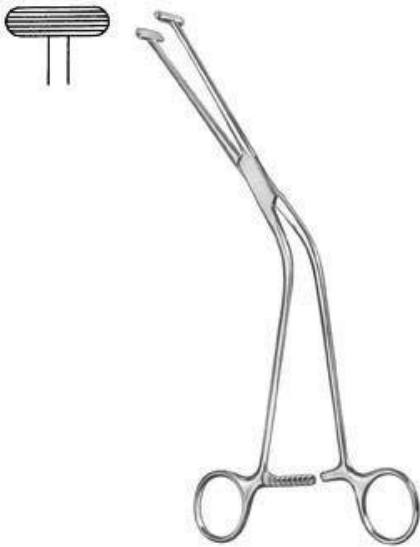

Millin

BS-19-119-23

Capsule Forceps
24.5 cm

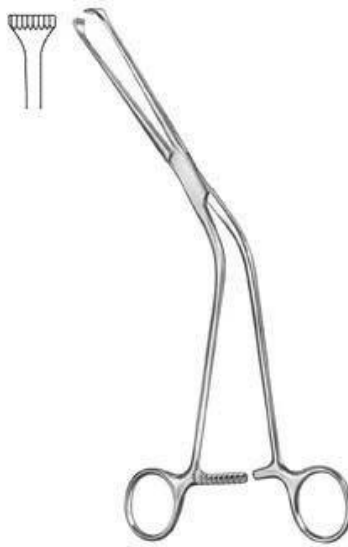

Millin

BS-19-120-23

Capsule Forceps
22 cm

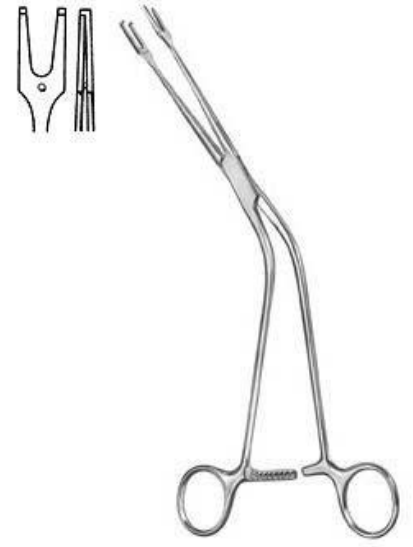

Millin

BS-19-121-24

Ligature Carrying Forceps
24.5 cm



Millin

BS-19-122-00

Bladder Neck Spreader
29



Thomson-Walker

BS-19-123-00

Bladder Retractor



Judd-Masson

BS-19-124-00

Bladder Retractor



Millin

BS-19-125-00 A

Bladder Retractor



Legueu

BS-19-126-27

Bladder Spatula
24 cm , 35 mm

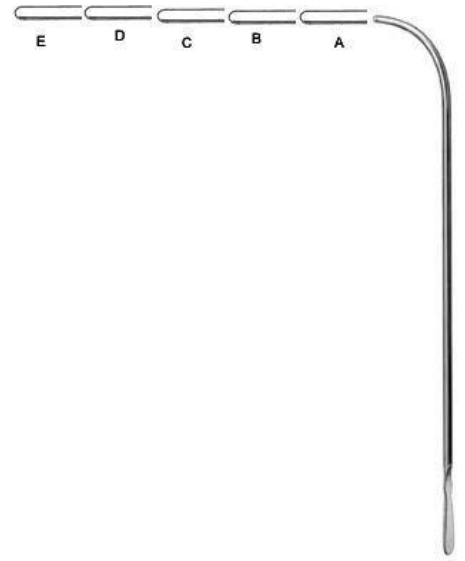

Van Buren

BS-19-127-00 A

Urethral Sound
27.5 cm

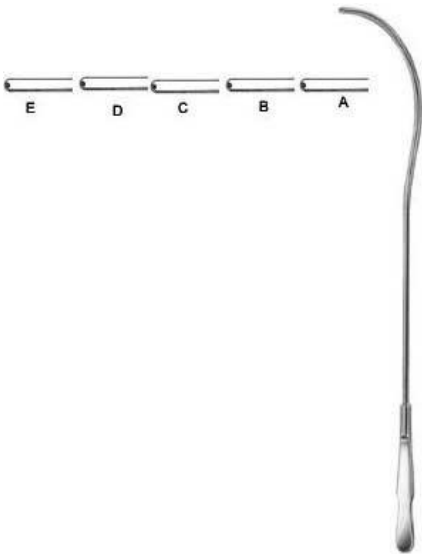

Guyon

BS-19-128-10 A

Urethral Sound
26 cm



Cusco

BS-20-101

Vaginal Speculum
75 x 32 mm, 85 x 35 mm



Cusco

BS-20-102-01

Vaginal Speculum
75 x 18 mm



Cusco

BS-20-103-01

Vaginal Speculum
80 x 22 mm, 100 x 25 mm, 105 x 27 mm



Cusco

BS-20-104-01

Vaginal Speculum
75 x 34 mm, 85 x 37 mm



Collin

BS-20-105-01

Vaginal Speculum
85 x 30 mm, 100 x 35 mm



Pederson

BS-20-106-01

Vaginal Speculum
75 x 13 mm, 100 x 22 mm



Grave

BS-20-107-01

Vaginal Speculum
75 x 20 mm, 95 x 35 mm

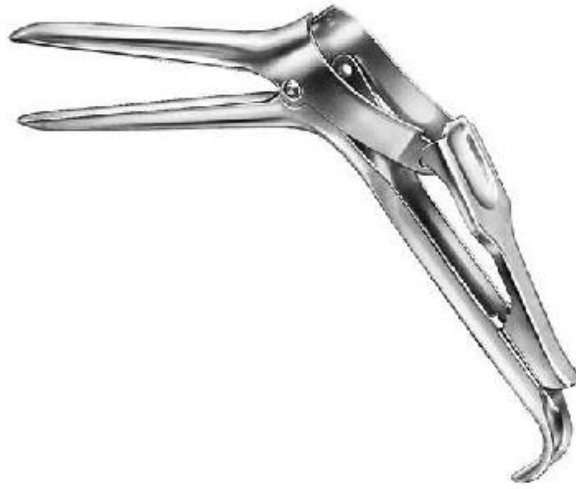

Semm

BS-20-108-01

Vaginal Speculum
100 x 20 mm, 105 x 27 mm



Sims

BS-20-109-01

Vaginal Speculum
65 x 25 mm, 70 x 30 mm



Kristeller

BS-20-110-01

Vaginal Speculum
70 x 27 mm



Kristeller

BS-20-111-01

Vaginal Retractor
75 x 23 mm



Kristeller

BS-20-112-01

Vaginal Speculum
Size 1



Kristeller

BS-20-113-01

Vaginal Speculum
105 x 18 mm



Kristeller

BS-20-114-01

Vaginal Retractor
110 x 14 mm



Kristeller

BS-20-115-01

Vaginal Speculum
Size 1

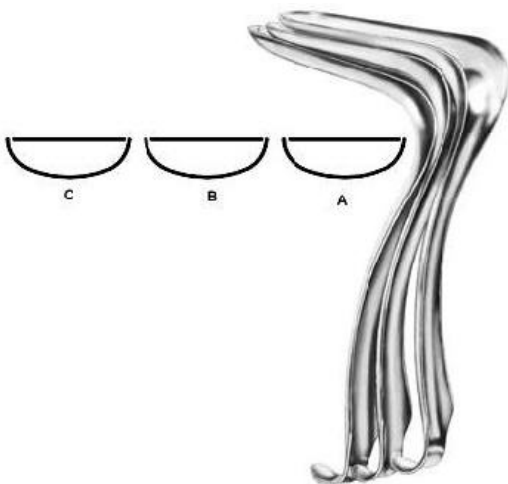

Kristeller

BS-20-116-01

Vaginal Speculum
105 x 26 mm

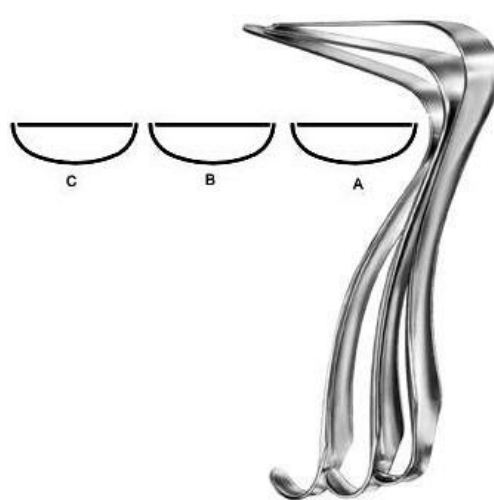

Kristeller

BS-20-117-01

Vaginal Retractor
115 x 22 mm, 115 x 23 mm

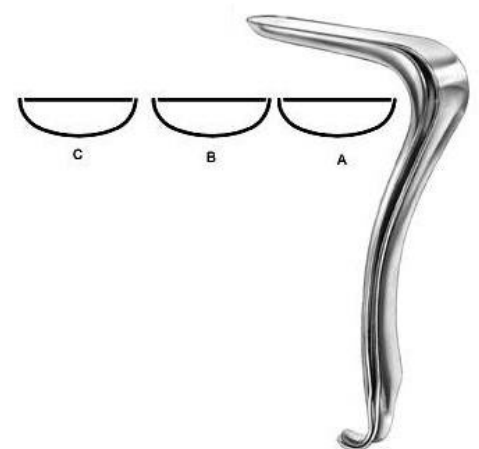

Kristeller

BS-20-118-01

Vaginal Speculum
Size 1

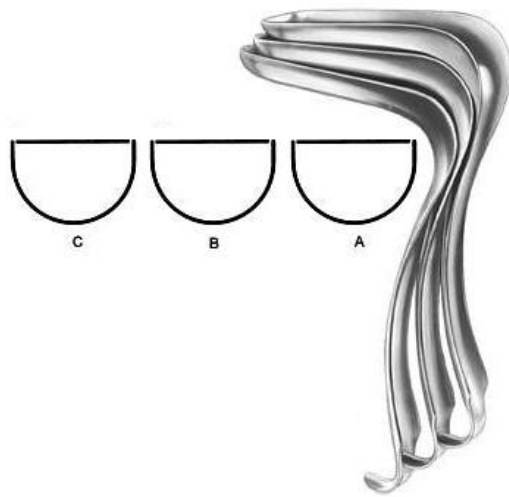

Kristeller

BS-20-119-01

Vaginal Speculum
110 x 27 mm

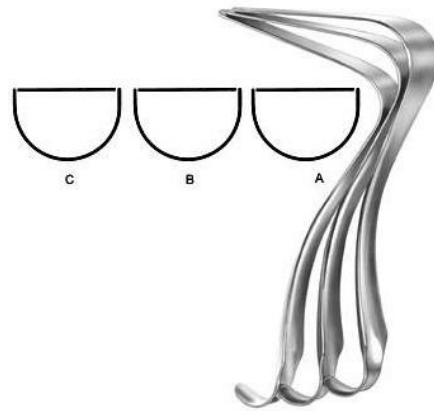

Kristeller

BS-20-120-01

Vaginal Retractor
115 x 23 mm

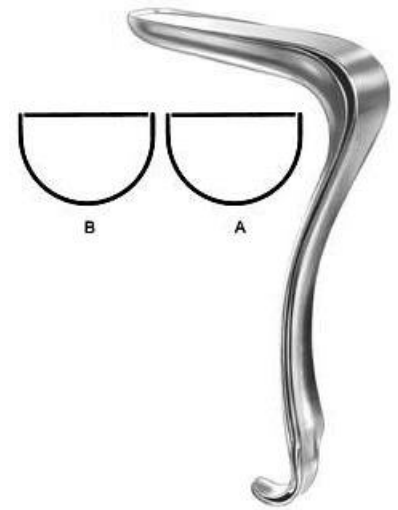

Kallmorgen

BS-20-121-01

Vaginal Speculum



Kallmorgen

BS-20-122-01

Vaginal Retractor
70 x 40 mm Fig. 1, 90 x 40 mm Fig. 2



Kallmorgen

BS-20-123-01

Vaginal Speculum
70 x 33 mm, 90 x 33 mm

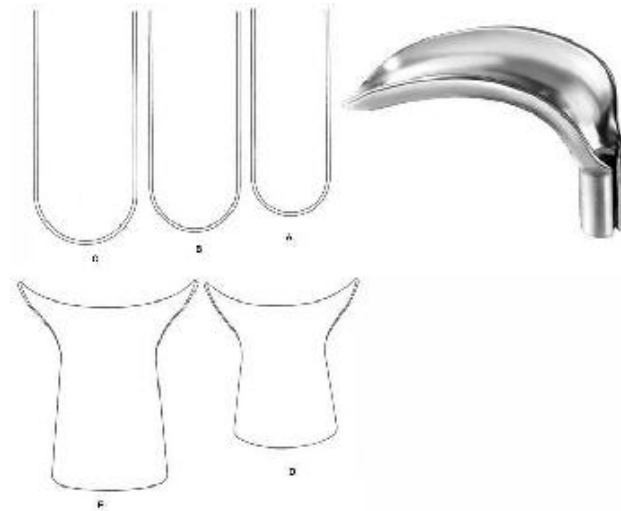

Scherbak

BS-20-125-00

Vaginal Speculum
Size 1



Auvard

BS-20-126-22

Vaginal Speculum
80 x 43 mm



Weissbarth

BS-20-127-24

Vaginal Speculum
21 cm 80 x 42 mm



Breisky

BS-20-128-20

Vaginal Speculum
29 cm 100 x 20 mm, 29 cm 100 x 25 mm



Kogan

BS-20-129-24

Endocervical Speculum
25 cm 70 x 30 mm



Kogan

BS-20-130-24

Endocervical Speculum
24.5 cm



Hegar

BS-20-131-24

Uterine Dilator
18.5 cm 1,0



Hegar

BS-20-132-02

Uterine Dilator
20 cm 1,0



Hank

BS-20-133-10

Uterine Dilator
26.5 cm Fig. 9/10



Sims

BS-20-134-32

Uterine Sound
33 cm



Valleix

BS-20-135-25

Uterine Sound
29.5 cm



Braun

BS-20-136-26

Uterine Depressor
27.5 cm



Schroder

BS-20-137-25

Uterine Tenaculum Forceps
25.5 cm



Braun

BS-20-138-25

Uterine Tenaculum Forceps
26 cm



Duplay

BS-20-139-28

Uterine Tenaculum Forceps
25.5 cm



Beacham

BS-20-140-26

Amniotome
26 cm



Skene

BS-20-141-24

Uterine Tenaculum Forceps
24 cm

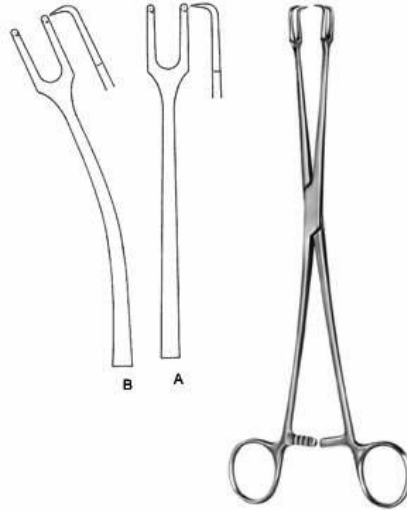

Schroder

BS-20-142-24

Uterine Tenaculum Forceps
25 cm



Teale

BS-20-143-23

Uterine Tenaculum Forceps
23.5 cm

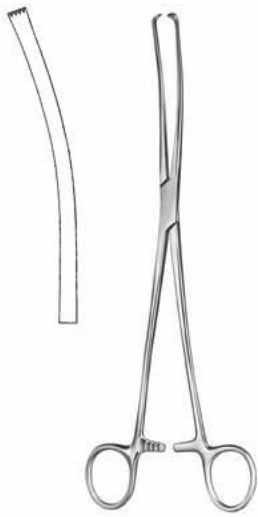

Iowa

BS-20-144-26

Uterine Tenaculum Forceps
26 cm



Museux

BS-20-145-24

Uterine Tenaculum Forceps
24 cm



Jacobs

BS-20-146-21

Uterine Tenaculum Forceps
21 cm

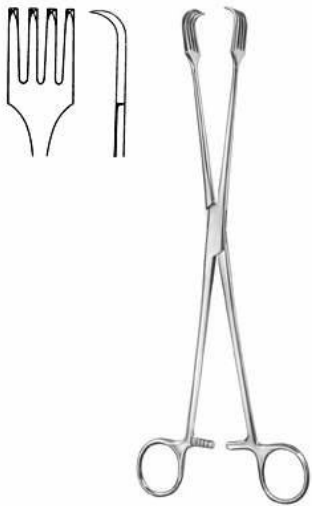

Uterine Tenaculum Forcep

BS-20-147-26

Uterine Tenaculum Forcep
26.5 cm



Braun

BS-20-148-16

Uterine Tenaculum Forceps
16 cm

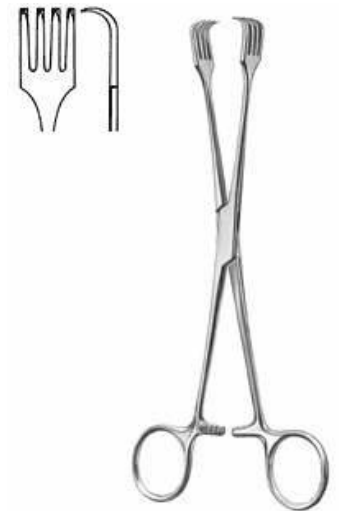

Czerny

BS-20-149-21

Uterine Tenaculum Forceps
21 cm



Kelly

BS-20-150-32

Uterine Polypus Forceps
32 cm



Noto

BS-20-151-27

Uterine Polypus Forceps
27 cm

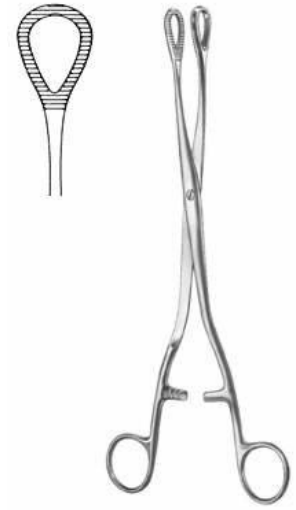

Heywood-Smith

BS-20-152-25

Uterine Polypus Forceps
25 cm

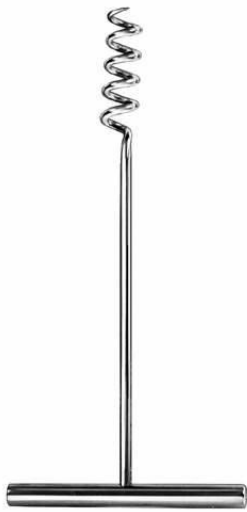

Doyen

BS-20-153-17

Myoma Screw
17 cm



Doyen

BS-20-154-17

Myoma Screw
14.5 cm



Segond

BS-20-155-27

Myoma Knife
28 cm

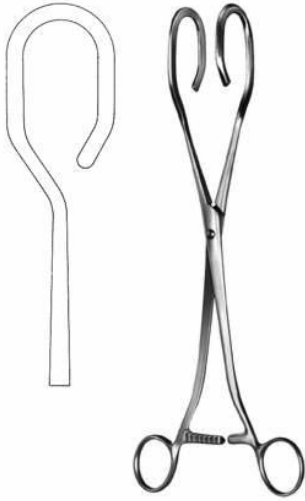

Dartigues

BS-20-156-27

Uterine Seizing Forceps

28 cm



Somer

BS-20-157-27

Uterine Seizing Forceps

22.5 cm



Collin

BS-20-158-25

Uterine Seizing Forceps jaw 40 mm wide

26 cm



Ayre

BS-20-159-23

Conization Knife cutting edge 3,6 mm wide

23.5 cm



Emmett

BS-20-160-03

Fistula Hook

22 cm Fig.3



Simon

BS-20-161-22

Fistula Hook

21.5 cm



Simon

BS-20-162-22

Fistula Hook
21.5 cm



Novak

BS-20-163-23

Suction Curette 4 mm ?
24.5 cm



Kevorkian

BS-20-164-23

Uterine Biopsy Curette 6,0 mm ?
30 cm



Munchen

BS-20-165-27

Uterine Biopsy Curette 4,8 mm ?
27 cm



Gellhorn

BS-20-166-23

Uterine Biopsy Forceps jaw 8,6 mm wide
24 cm



Faure

BS-20-167-21

Faure Uterine Biopsy Forceps
21 cm

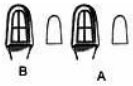

Schubert

BS-20-168-21

Uterine Biopsy Forceps jaw 4,8 mm wide
21.5 cm, 28 cm

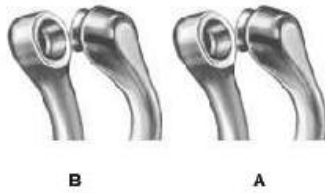

Thoms-Gaylor

BS-20-169-22

Uterine Biopsy Forceps jaw 5,6 mm ?
21 cm, 23.5 cm

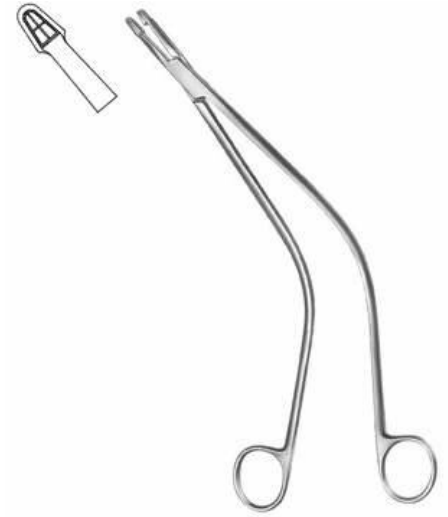

Schubert

BS-20-170-26

Schubert Uterine Biopsy Forceps
25.5 cm

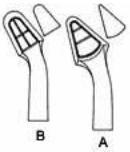

Van Doren

BS-20-171-24

Uterine Biopsy Forceps jaw 4,9 mm wide
27 cm, 25.5 cm



Alexander

BS-20-172-28

Uterine Biopsy Forceps jaw 5,1 mm wide
28 cm



Kevorkian

BS-20-173-32

Uterine Biopsy Forceps
25 cm

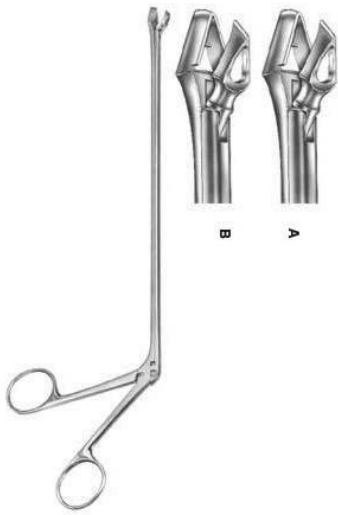

Schumacher

BS-20-174-01

Uterine Biopsy Forceps jaw 4,6 / 5,4 mm wide
24 cm



Schumacher

BS-20-175-00

Uterine Biopsy Forceps
25 cm



IUP Grasping Forceps 3 Mm ?

BS-20-176-22

IUP Grasping Forceps 3 mm ?
22 cm

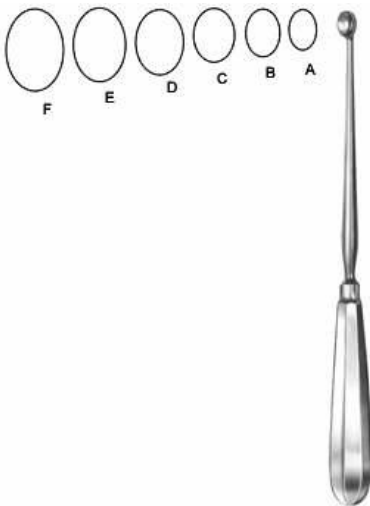

Simon

BS-20-177-01

Uterine Scoop
24.5 cm 9,8 x 8,6 mm, 24.5 cm 11,6 x 8,3 mm



Simon

BS-20-178-01

Uterine Scoop
30 cm 9,8 x 8,6 mm, 30 cm 11,6 x 8,3 mm



Recamier

BS-20-179-05

Uterine Curette
31 cm Fig. 00 5 mm, 31 cm Fig. 0 6 mm



Recamier

BS-20-180-05

Uterine Curette

31 cm Fig. 00 5 mm, 31 cm Fig. 0 6 mm



Sims

BS-20-181-05

Uterine Curette

31 cm Fig. 00 5 mm, 31 cm Fig. 0 6 mm

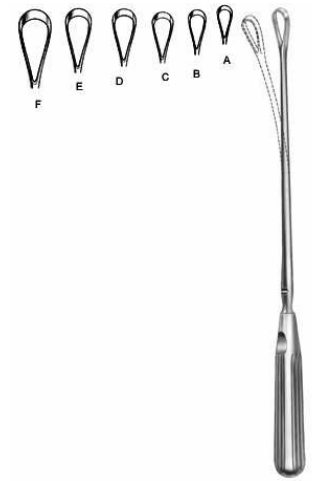

Sims

BS-20-182-05

Uterine Curette

31 cm Fig. 00 5 mm, 31 cm Fig. 0 6 mm

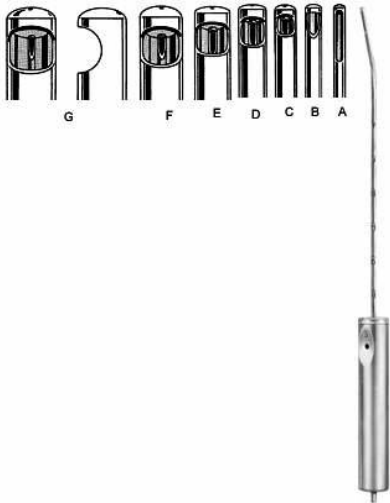

Suction Curette

BS-0-183-03

Suction Curette

29 cm 3,0 mm ?, 29 cm 4,5 mm ?, 29 cm 6,0 mm ?



Martin

BS-21-101-34

Pelvimeter cm, inch scale
34 cm



Nagele

BS-5-102-36

Obstetrical Forceps
35 cm, 40.5 cm



Simpson

BS-5-103-30

Obstetrical Forceps
31 cm



Wrigley

BS-5-104-28

Obstetrical Forceps
28 cm



Simpson

BS-21-105-36

Obstetrical Forceps
36.5 cm



Kielland

BS-21-106-41

Obstetrical Forceps
42 cm

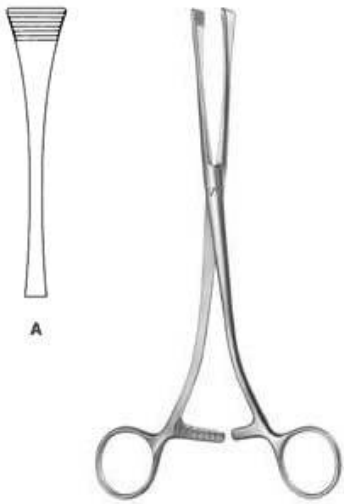

Green-Armytage

BS-21-107-21

Uterine Clamp
21 cm



Sellheim

BS-21-108-28

Obstetrical Lever
32 cm

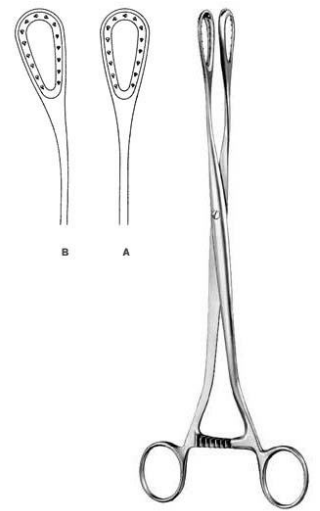

Sanger

BS-21-109-27

Placenta and Ovum Forceps
27.5 cm, 27 cm

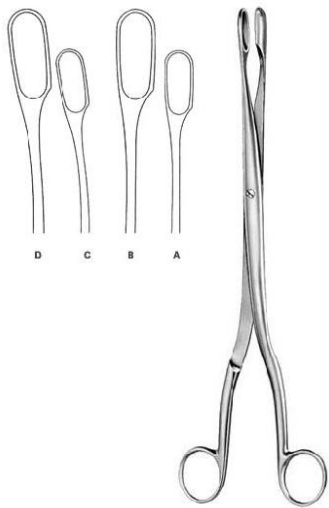

Winter

BS-21-110-01

Placenta and Ovum Forceps
28 cm Fig. 1, 28 cm Fig. 2

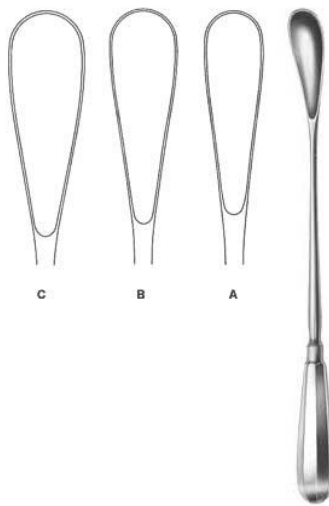

Cuzzi

BS-21-111-01

Placenta Scoop
30 cm 14,5 mm, 30 cm 18 mm



Pestalozza

BS-21-112-30

Placenta Scoop
30 cm

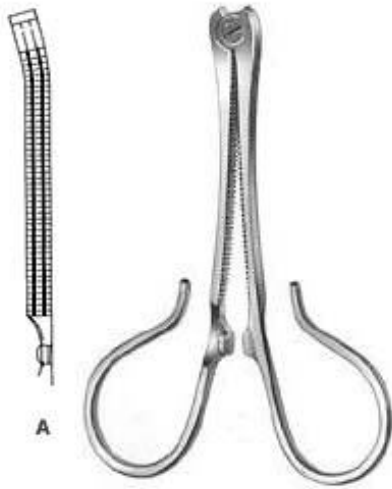

Kane

BS-21-113-08

Umbilical Cord Clamp
8.5 cm



Collin

BS-21-114-09

Umbilical Cord Clamp
8.5 cm



Irrigator

BS-23-101-10

Sterilization
Size 1



Round Bowl

BS-23-102-16

Sterilization
220 mm x 70 mm, 400 mm x 150 mm



Round Bowl

BS-23-103-33

Sterilization
? x h 6,00 l



Flat Dish

BS-23-104-11

Sterilization
? x h 0,20 l



Lid Only

BS-23-105-11

Sterilization
Size 1



Stainless Steel

BS-23-106-04

Sterilization
? x h 0,30 l



Round Dish

BS-23-107-11

Sterilization

? x h 0,30 l, ? 128 x 38 mm 0,40 l



Flat Dish

BS-23-108-11

Sterilization

? x h 0,15 l



Measurer

BS-23-109-01

Graduated inside

100cc = 0,1 l



Measurer

BS-23-110-02

Graduated Inside

0,25 l, 0,50 l



Petri Dish

BS-23-111-10

with Lid ? x h



Petri Dish

BS-23-112-09

without lid ? x h

Size 1



Lid For Petri Dishes

BS-23-113-10

Sterilization
Size 1



Universal Tray

BS-23-114-23

Sterilization
l x b x h



Instrument Tray

BS-23-115-21

Sterilization
l x b x h



Universal Tray

BS-23-116-23

Sterilization
l x b x h



Round Bowl

BS-23-117-22

Sterilization
? x h



Metal Jar

BS-23-118-30

Sterilization
? 30mm x 90 mm, ? 50mm x 100 mm



Instrument Box

BS-23-119-16

lid with knob
l x b x h



Instrument Box

BS-23-120-16

lid with knob
l x b x h



Instrument Box

BS-23-121-20

Sterilization
l x b x h



Round Metal Box

BS-23-122-06

Sterilization
? 75 mm x 75 mm, ? 100 mm x 60 mm



Medicine Cup Graduated Inside

BS-23-123-25

Sterilization
25 cm



Medicine Cup Graduated Inside

BS-23-124-50

Sterilization
50 cm



Tablet Tray

BS-23-125-75

Sterilization
? 75 mm x 12 mm



Metal Cup

BS-23-126-90

Sterilization
? 90 mm x 90 mm



Denture Cup

BS-23-127-75

Sterilization
? 75 mm x 50 mm



Insert For Cup

BS-23-128-75

Sterilization
? 73 mm x 75 mm



Kidney Dish

BS-23-129-17

Kidney Dish
l x b x h



Placenta Pan

BS-23-130-36

Sterilization
Size 1



Waste Cotton Collector

BS-23-131-01

Sterilization
? 50 mm x 75 mm



Spirit Lamp

BS-23-132-07

Sterilization
120 cm



Charri?Re

BS-7-102-35

Amputation Saw
35 cm



Langenbeck

BS-7-103-23

Amputation Saw
24.5 cm



Charriere

BS-7-104-27

Amputation Saw
26.5 cm



Reamer

BS-7-105-14

Reamer
13.5 cm



Perthes

BS-7-106-18

Reamer
18 cm

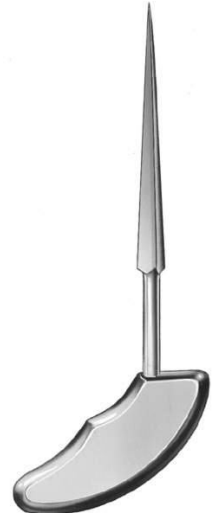

Perthes

BS-7-107-21

Reamer
21.5 cm



Reamer

BS-7-108-14

Reamer
14 cm



Flat Trephine

BS-7-111-18

Flat Trephine

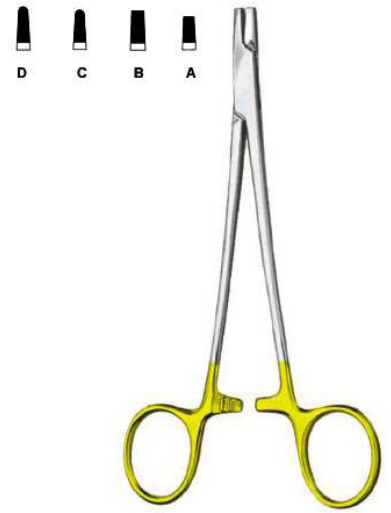

Wire Twisting Forceps

BS-7-112-01

Wire Twisting Forceps
15.5 cm, 18 cm, 20 cm



Wire Twisting Forceps

BS-7-113-15

Wire Twisting Forceps
15.5 cm



Flat Nose Plier

BS-7-114-17

Flat Nose Plier
18.5 cm



Wire Twisting Forceps

BS-7-115-18

Wire Twisting Forceps
19 cm



Combi-Flat Nose Plier

BS-7-116-15

Combi-Flat Nose Plier
15 cm

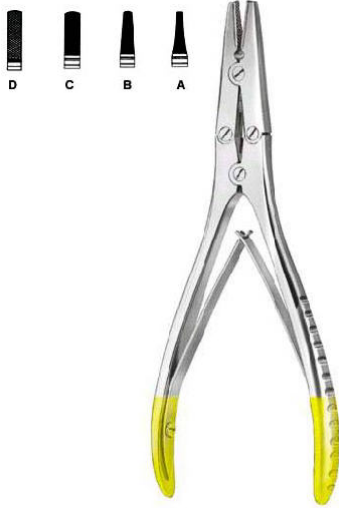

Flat Nose Plier

BS-7-117-01

Flat Nose Plier
18 cm

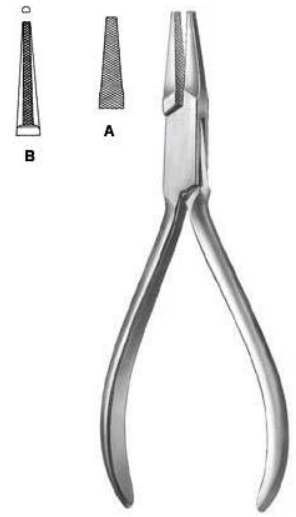

Flat Nose Plier

BS-7-118-14

Flat Nose Plier
13.5 cm



Hackstock

BS-7-119-16

Flat Nose Plier
16 cm



Flat Nose Plier

BS-7-120-01

Flat Nose Plier
17.5 cm



Wire Cutting Pliers

BS-7-121-18

Wire Cutting Pliers
18.5 cm



Wire Cutting Pliers

BS-7-122-15

Wire Cutting Pliers
15 cm



Wire Cutting Pliers

BS-7-123-18

Wire Cutting Pliers
17.5 cm

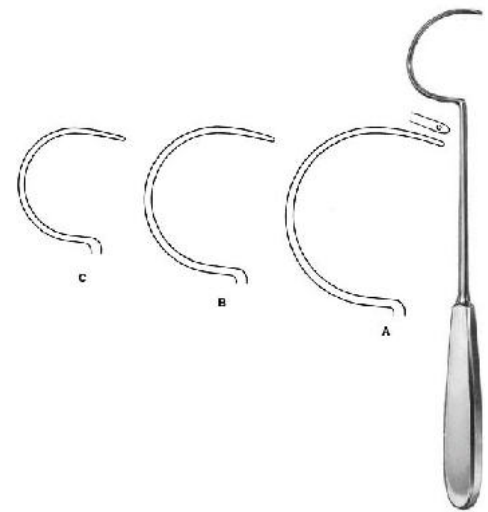

Demel

BS-7-124-18

Wire Guide
28 cm Fig. 3 , 29 cm Fig. 2 , 31 cm Fig. 1

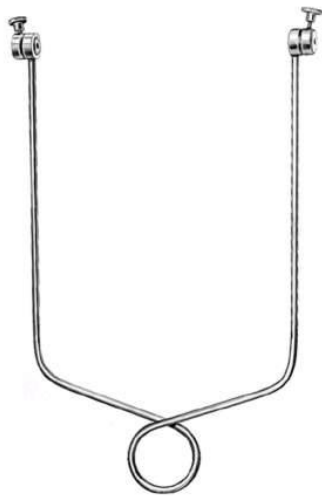

Bohler

BS-7-125-15

Extension Bow



Kirschner

BS-7-126-01

Extension Bow
18.5 cm , 26.5 cm



Traction Hook For Extention Bows

BS-7-127-06

Traction Hook for Extention Bows



Kirschner

BS-7-128-06

Wire Drill
6 cm, 12 cm



Kirschner

BS-7-129-06

Wire Drill
14 cm, 16 cm



Kirschner

BS-7-130-10

Wire Drill
31 cm



Kirschner

BS-7-131-10

Wire Drill
12 cm, 16 cm, 18 cm



Kirschner

BS-7-132-10

Wire Drill
31 cm

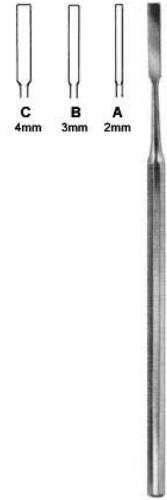

Buckley

BS-7-133-02

Chisel
16 cm



Buckley

BS-7-134-02

Gouge
16 cm



Stout

BS-7-135-03

Bone Chisel
21 cm



Bone Chisel

BS-7-112-01

Bone Chisel
18 cm



Bone Chisel

BS-7-137-04

Bone Chisel
18 cm



Bone Chisel

BS-138-04

Bone Chisel
17 cm



Bone Chisel

BS-7-139-04

Bone Chisel
17 cm

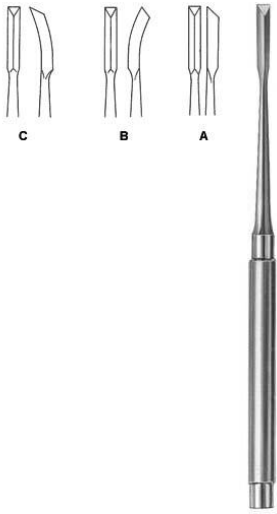

Gardner

BS-7-112-01

Bone Chisel
17 cm 4mm



Snyder-O.S.U

BS-7-141-03

Bone Chisel
16.5 cm 3mm , 16.5 cm 5.5mm



O.S.U.

BS-7-142-01

one Chisel
17 cm 7mm



O.S.U.

BS-7-143-01

One Chisel
17 cm 9mm



Osteotome

BS-7-144-03

Osteotome
13.5 cm 8mm , 13.5 cm 10mm , 13.5 cm 12mm ,
13.5 cm 14mm , 13.5 cm 16mm

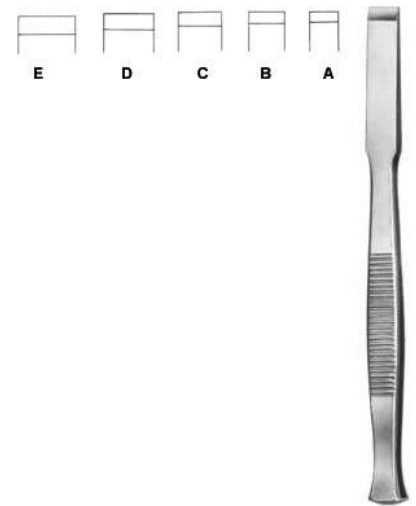

Chisel

BS-7-145-08

Chisel
13.5 cm 8mm , 13.5 cm 10mm , 13.5 cm 12mm ,
13.5 cm 14mm , 13.5 cm 16mm



Gouge

BS-7-146-08

Gouge

13.5 cm 8mm , 13.5 cm 10mm , 13.5 cm 12mm ,
13.5 cm 14mm , 13.5 cm 16mm



Partsch

BS-7-147-02

Chisel

13.5 cm 2mm , 13.5 cm 3mm , 13.5 cm 4mm , 13.5
cm 5mm , 13.5 cm 6mm , 17 cm 2mm , 17 cm
3mm , 17 cm 4mm , 17 cm 5mm , 17 cm 6mm



Partsch

BS-7-148-02

Gouge

13.5 cm 2mm , 13.5 cm 3mm , 17 cm 2mm , 17 cm
3mm

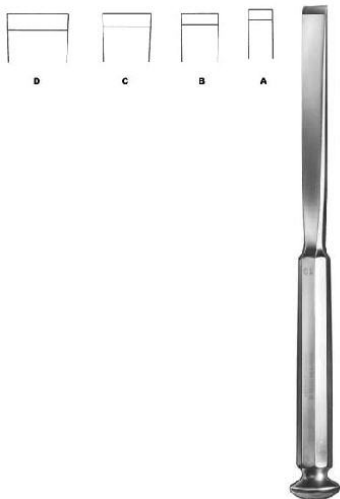

Stille

BS--7-149

Chisel

20 cm 10mm , 20 cm 15mm , 20 cm 20mm , 20
cm 25mm



Stille

BS--7-150

Osteotome

20 cm 10mm , 20 cm 15mm , 20 cm 20mm , 20
cm 25mm



Stille

BS-7-151-10

Gouges

20 cm 10mm , 20 cm 15mm , 20 cm 20mm , 20
cm 25mm



Lambotte, Mini

BS-7-152-02

Osteotome

12.5 cm 2mm , 12.5 cm 3mm , 12.5 cm 4mm ,
12.5 cm 6mm



Lambotte

BS-7-153-15

Osteotome

24 cm 15mm , 24 cm 20mm , 24 cm 25mm , 24
cm 30mm



Lambotte

BS-7-154-15

Osteotome

24 cm 15mm , 24 cm 20mm , 24 cm 25mm , 24
cm 30mm



Smith-Petersen

BS-7-155-06

Osteotome

20.5 cm 6mm , 20.5 cm 9mm , 20.5 cm 13mm



Smith-Petersen

BS-7-156-06

Osteotome

20.5 cm 6mm , 20.5 cm 9mm , 20.5 cm 13mm ,
20.5 cm 16mm , 20.5 cm 19mm



Smith-Petersen

BS-7-157-09

Gouge

20.5 cm 9mm , 20.5 cm 14mm , 20.5 cm 19mm ,
20.5 cm 25mm



Smith-Petersen

BS-7-158-09

Gouge

20.5 cm 9mm , 20.5 cm 14mm , 20.5 cm 19mm



Hoke

BS-7-159-03

Osteotome

17 cm 3mm , 17 cm 5mm , 17 cm 6mm , 17 cm 8mm

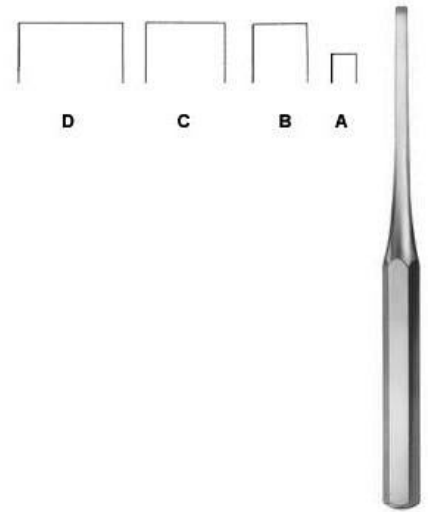

Hibbs

BS-7-151-10

Osteotome

24.5 cm 6mm , 24.5 cm 13mm , 24.5 cm 19mm

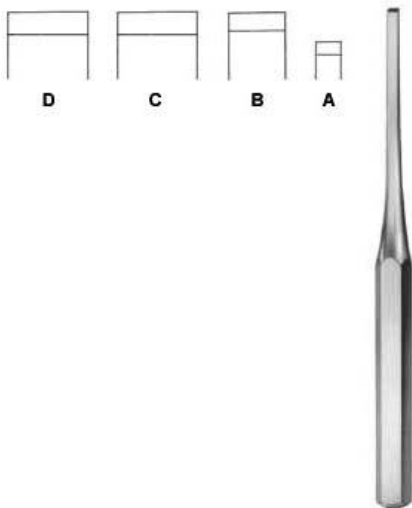

Hibbs

BS-7-161-06

Chisel

24.5 cm 6mm , 24.5 cm 13mm , 24.5 cm 19mm

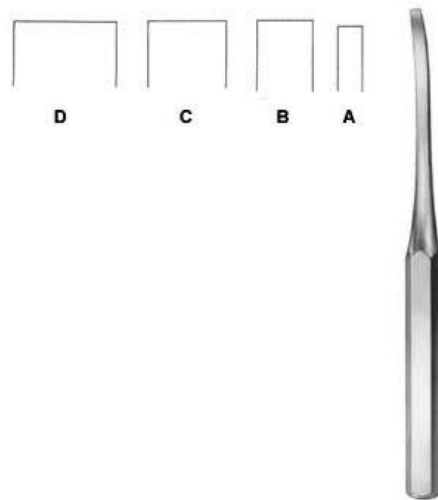

Hibbs

BS-7-162-06

Osteotome

24.5 cm 6mm , 24.5 cm 13mm , 24.5 cm 19mm

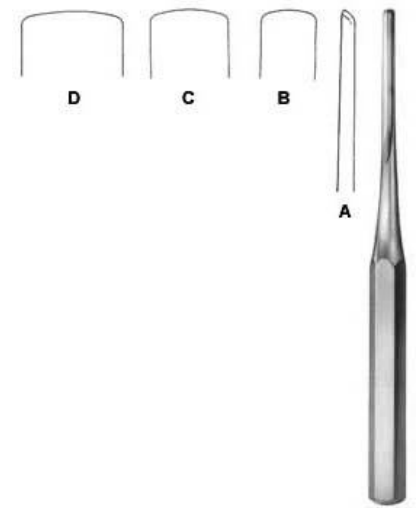

Hibbs

BS-7-163-06

Hibbs

24.5 cm 6mm , 24.5 cm 13mm , 24.5 cm 19mm



Bone Surgery



Hibbs

BS-7-164-06

Gouge

24.5 cm 6mm , 24.5 cm 13mm , 24.5 cm 19mm

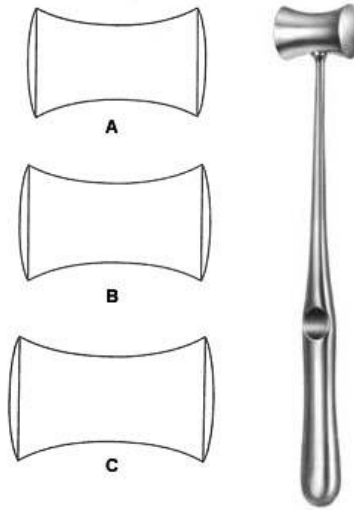

Williger

BS-7-165-01

Mallet

24 cm

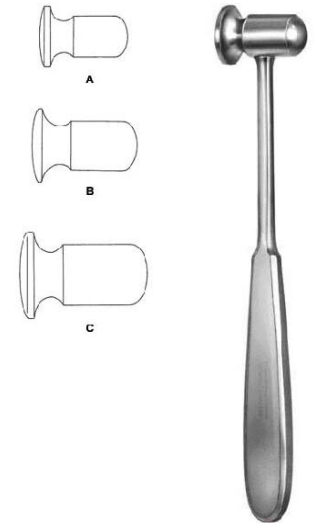

Doyen

BS-7-166-01

Mallet

20.5 cm, 21 cm, 21.5 cm



Collin

BS-7-151-10

Mallet

20 cm

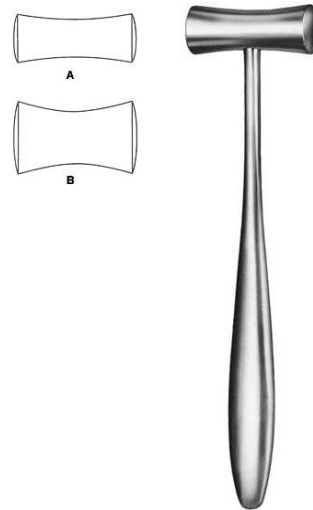

Lucae

BS-7-168-01

Mallet

19.5 cm



Cottle

BS-7-169-19

Mallet

19 cm



Williger

BS-7-170-01

Mallet

16.5 cm



Mead

BS-7-171-17

Mallet

19 cm



Partsch

BS-7-172-18

Mallet

19 cm

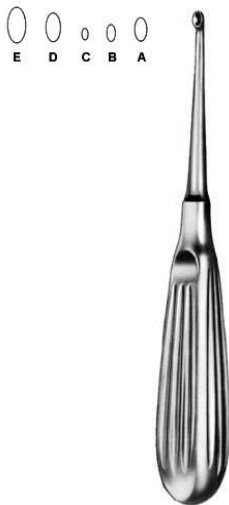

Schede

BS-7-173-01

Bone Curette Fig. 0 to 4

17 cm



Kahre-Williger

BS-7-201-04

Periosteal Elevator

4 mm, 5 mm, 7 mm



Periosteal Elevator

BS-7-202-06

Periosteal Elevator

17 cm 6mm , 17 cm 8mm



Volkman

BS-7-174-01

Bone Curette

17 cm Fig. 0, 17 cm Fig. 00, 17 cm Fig. 000, 17 cm Fig. 1, 17 cm Fig. 2, 17.5 cm Fig. 3, 17.5 cm Fig. 4



Doyen

BS-7-203-17

Rib Raspatory

17.5 cm

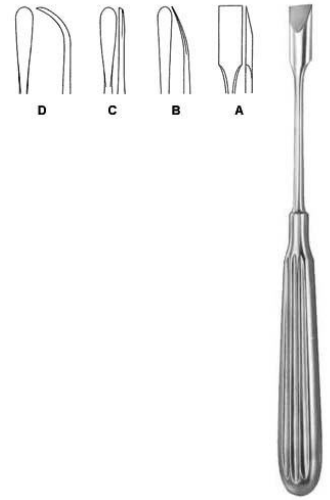

West

BS-7-204-19

Periosteal Elevator, double-ended

17 cm, 17.5 cm

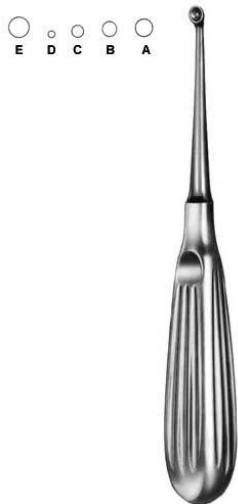

Bruns

BS-7-175-01

Bone Curette

17 cm Fig. 0, 17 cm Fig. 00, 17 cm Fig. 000, 17 cm Fig. 1, 17 cm Fig. 2, 17 cm Fig. 3, 17 cm Fig. 4

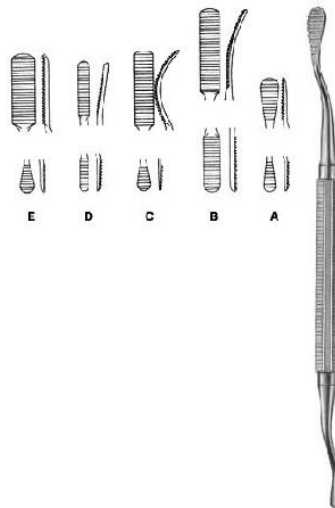

Miller-Colburn

BS-7-209-01

Bone File

18 cm Fig. 1, 18 cm Fig. 2, 18 cm Fig. 3, 18 cm Fig. 4, 18 cm Fig. 5



Spratt

BS-7-175-01

Bone Curette

17 cm Fig. 0, 17 cm Fig. 00, 17 cm Fig. 000, 17 cm Fig. 0000, 17 cm Fig. 1, 17 cm Fig. 2, 17 cm Fig. 3, 17 cm Fig. 4, 17 cm Fig. 5

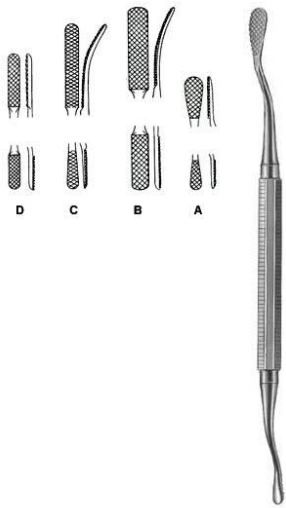

Miller-Colburn

BS-7-210-01

Bone File

18 cm Fig. 1, 18 cm Fig. 2, 18 cm Fig. 3, 18 cm Fig. 4



Langenbeck

BS-7-211-20

Elevator



Bruns

BS-7-177-01

Bone Curette

23 cm Fig. 0, 23 cm Fig. 00, 23 cm Fig. 000, 23 cm Fig. 1, 23 cm Fig. 2, 23 cm Fig. 3

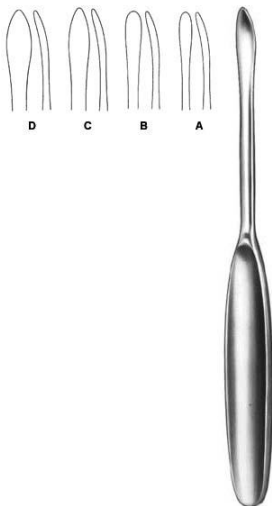

Martin-Langenbeck

BS-7-212-01

Elevator

17 cm 5mm, 17 cm 7mm, 17 cm 8mm



Scoville

BS-7-178-25

Bone Curette

25 cm



Vickers

BS-7-213-17

Elevator

17 cm



Vickers
BS-7-214-17
 Dissector
 17 cm

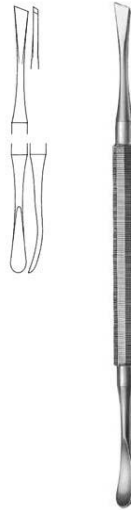

Simon
BS-7-179-01
 Bone Curette
 25 cm Fig. 1, 25 cm Fig. 2, 25 cm Fig. 3, 25 cm Fig. 4, 25 cm Fig. 5



Williger
BS-7-215-17
 Elevator
 16.5 cm 5.5mm



Modell USA
BS-7-180-01
 Bone Curette
 16 cm Fig. 1, 16 cm Fig. 2, 16 cm Fig. 3, 16 cm Fig. 4



Williger
BS-7-216-16
 Elevator
 16.5 cm 5.5mm



Mead
BS-7-217-17
 Mallet
 19 cm



Periosteal Elevator

BS-7-218-18

Periosteal Elevator



Hohmann

BS-7-219-43

Bone Lever
23.5 cm



Modell USA

BS-7-181-01

Bone Curette
15.5 cm Fig. 1 , 15.5 cm Fig. 2 , 15.5 cm Fig. 3 ,
15.5 cm Fig. 4



Lempert

BS-7-220-19

Bone Rongeur
19 cm



Modell USA

BS-7-182-01

Bone Curette
15.5 cm Fig. 1 , 15.5 cm Fig. 2 , 15.5 cm Fig. 3 ,
15.5 cm Fig. 4

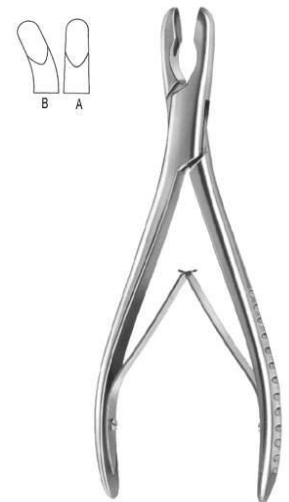

Luer

BS-7-221-17

Bone Rongeur
18 cm, 18.5 cm



Zaufal-Jansen

BS-7-222-18

Bone Rongeur
18 cm



Halle

BS-7-183-01

Bone Curette
21 cm Fig. 1 , 21 cm Fig. 2, 21 cm Fig. 3

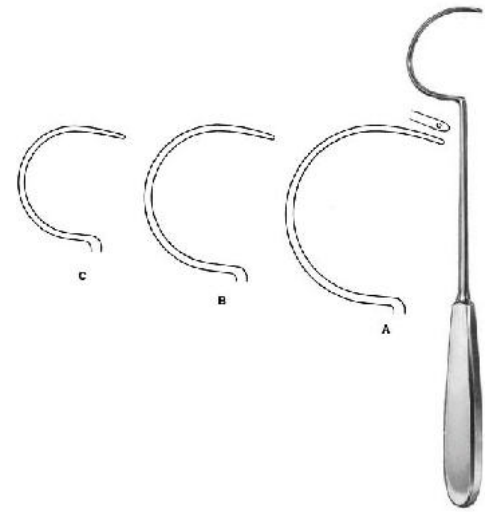

Demel

BS-7-124-01

Wire Guide
31 cm Fig. 1



Volkman

BS-7-184-01

Bone Curette, double-ended
12.5 cm, 14.5 cm , 17 cm



Volkman

BS-7-185-13

Bone Curette, double-ended
13 cm , 16 cm



Bone Curette

BS-7-186-21

Bone Curette, double-ended
21 cm



Williger

BS-7-187-00

Bone Curette, double-ended

13.5 cm Fig. 00/0 , 13.5 cm Fig. 0/1 , 13.5 cm Fig. 1/2



Hemingway

BS-7-189-11

Bone Curette, double-ended

18 cm



Hemingway

BS-7-190-00

Bone Curette, double-ended

18.5 cm



Bone Curette

BS-7-191-01

Bone Curette, double-ended

17.5 cm

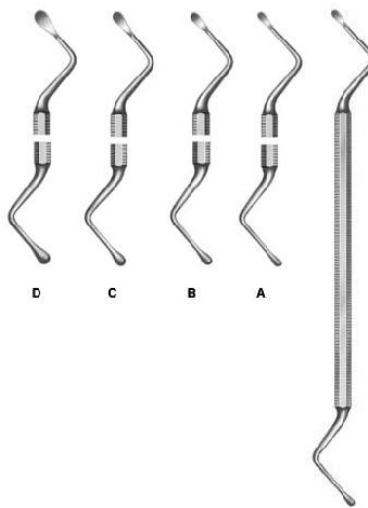

Lucas

BS-7-192-11

Bone Curette, double-ended

18 cm

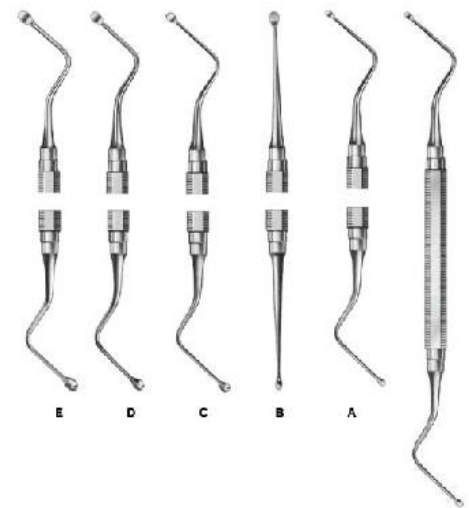

Miller-Colburn

BS-7-193-00

Bone Curette, double-ended

17 cm Fig. 0, 17 cm Fig. 1, 17 cm Fig. 2, 17 cm Fig. 3

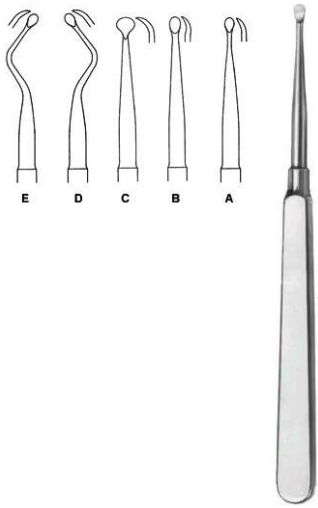

Molt

BS-7-194-01

Bone Curette

17 cm Fig. 1, 17 cm Fig. 2, 17 cm Fig. 3, 17 cm Fig. 4

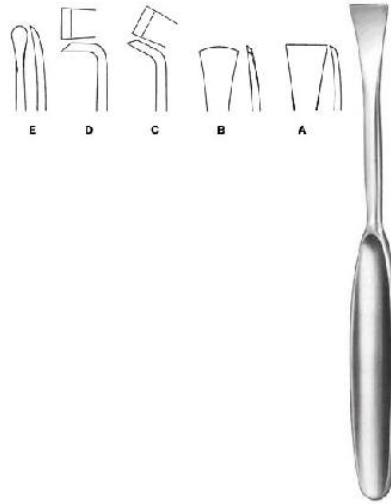

Martin-Langenbeck

BS-7-195-01

Periosteal Elevator

19 cm 16mm



Langenbeck

BS-7-196-18

Periosteal Elevator

18.5 cm



Langenbeck

BS-7-197-19

Periosteal Elevator

19.5 cm



Periosteal Elevator

BS-7-198-05

Periosteal Elevator



Sedillot

BS-7-199-21

Periosteal Elevator

22 cm 15mm



Williger

BS-7-200-13

Periosteal Elevator
12.5 cm 5mm



Kahre-Williger

BS-7-201-04

Periosteal Elevator
4 mm, 5 mm, 7 mm

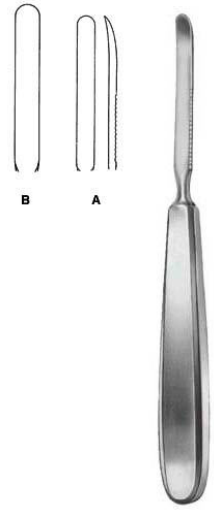

Periosteal Elevato

BS-7-202-06

Periosteal Elevato
17 cm 6mm , 17 cm 8mm



Doyen

BS-7-203-17

Rib Raspatory
17.5 cm

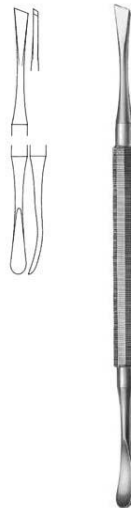

West

BS-7-204-19

Periosteal Elevator, double-ended
18.5 cm